



*Ordine in movimento*  
**L'Ordine en mouvement**

L'Évolution dell'allestimento per veicoli commerciali  
L'Évolution de l'aménagement pour VUL



Allestimento automezzi  
Aménagement de véhicules utilitaires



Company Tecno A Italy



Production Tecno A Italy

**Order System** nel mondo, un partner affidabile in efficienza e sicurezza.

**Order System** è un produttore di allestimenti conosciuto in tutto il mondo per la sua qualità, funzionalità e flessibilità.

**Order System**, dans le monde, un partenaire fiable pour l'efficacité et la sécurité.

**Order System**, est un fabricant dont les matériels sont connus mondialement pour leur qualité, leur fonctionnalité et leur flexibilité.

OUR CERTIFICATIONS



FLOORS



LININGS



CRASH TEST



CRASH TEST



RAMPS



LADDER RACKS

**LAVORARE E GUIDARE IN SICUREZZA**

Tecno A S.r.l. ha eseguito un nuovo crash test per gli allestimenti Order System®, alla velocità di 60 km/h e ha superato brillantemente la prova al primo tentativo dimostrando la qualità del prodotto. Il crash test è stato eseguito in Francia presso VALUTEC S.A. dipartimento C3T (Centro Tecnologico in Trasporti Terrestri). Order System® tiene molto alla salute e alla sicurezza dei suoi clienti.

**TRAVAILLER ET CONDUIRE EN TOUTE SÉCURITÉ**

TECNO A S.r.l. a réalisé un nouveau crash-test pour les équipements de véhicules utilitaires Order System® à une vitesse de 60km/h et a réussi ce test avec succès au premier essai, en démontrant la qualité de ses produits. Le crash-test a été réalisé en France chez VALUTEC S.A. au département C3T (Centre Technologique de Transport Terrestre). Order System® prête toute son attention à la santé et la sécurité de ses clients.

**DRIVING SAFELY**  
with Order System®  
Van Equipment

**CERTIFIED QUALITY**



BEFORE



AFTER



**GARANZIA 3 ANNI** Il materiale Order System<sup>®</sup> dal momento in cui è montato ha una garanzia di 3 anni per i difetti di costruzione.  
**GARANTIE 3 ANS** Les produits Order System<sup>®</sup> bénéficient d'une garantie de 3 ans (contre tout défaut ou vice de fabrication) à compter de la date d'installation.

**FINANZIABILITÀ** Il materiale Order System<sup>®</sup> può essere inserito senza problemi nel finanziamento d'acquisto del vostro veicolo.  
**FINANCEMENT** Les produits Order System<sup>®</sup> peuvent être intégrés au financement de votre utilitaire.



**MERCEDES CITAN**

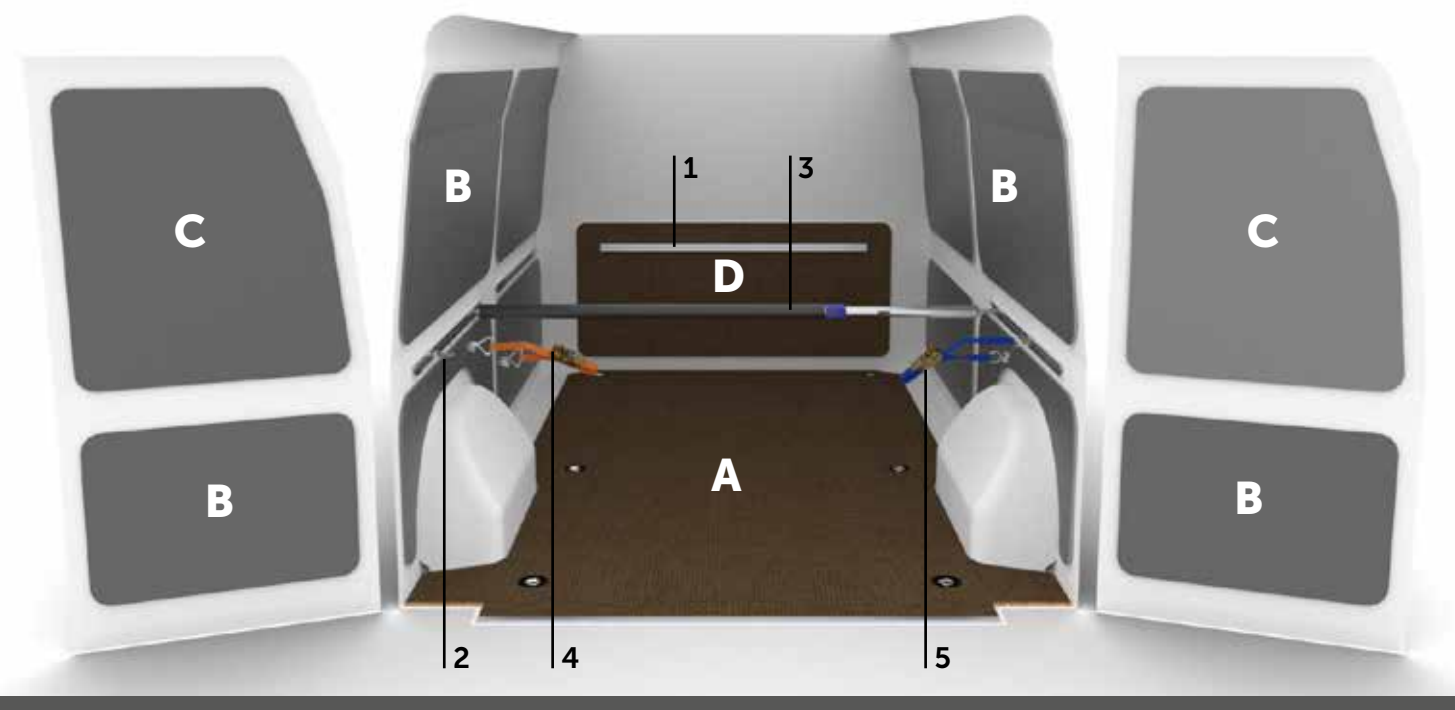

VEICOLO VÉHICULE	PIANALE PLANCHER	RIVESTIMENTO INTERNO REVÊTEMENT INTERIEUR	RIVESTIMENTO INTERNO REVÊTEMENT INTERIEUR	PARATIA DIVISORIA PAROI DE SÉPARATION
	A	B	C	D
L1 H1	9PKPL08009	9RKPL0800P	9RK080001P	-
L1 H1*	9PKPL08019	9RKPL0800P	9RK080001P	-

\* paratia in rete con cancelletto - paroi en réseau avec hachage



Preferisci una soluzione su misura per le tue esigenze? **Contattaci per un progetto personalizzato**  
Préférez-vous une solution sur mesure pour vos besoins? **Contactez-nous pour un projet personnalisé**

**PIANALI E RIVESTIMENTI - PLANCHERS ET REVÊTEMENT**

**PIANALE  
PLANCHER**

**A**



Pianale in multistrato marino sp. 9mm con rivestimento fenolico e predisposizione per gli ancoraggi originali del veicolo.

Plancher multi couche marin épaisseur 9 mm, avec revêtement phénolique et prédisposition pour les fixations d'origine du véhicule.

**RIVESTIMENTI INTERNI  
REVÊTEMENT INTERIEUR**

**B**



Pannellatura integrale in polipropilene sp. 4mm ad esclusione delle porte posteriori superiori.

Revêtement complet en polypropylène épaisseur 4 mm. sans portes arrière supérieures.

**PARATIA DIVISORIA  
ARRET DE CHARGE**

**D**

Paratia divisoria in multistrato marino con rivestimento fenolico.

Arret de charge en multi couche marin avec revêtement phénolique

**RIVESTIMENTI INTERNI  
REVÊTEMENT INTERIEUR**

**C**

Pannellatura per le porte posteriori superiori in polipropilene.

Revêtement pour les portes arrière supérieures en polypropylène.

**ACCESSORI BLOCCAGGIO MATERIALI - ACCESSOIRES POUR BLOCAGE DE MATÉRIEL**

**BARRE FERMACARICHI IN ALLUMINIO  
RAIL AERO EN ALUMINIUM**

**1**

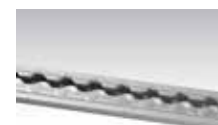

DIMENSIONI - DIMENSIONS	CODICE - CODE
L=3000mm	9ABR00009
L=2000mm	9ABR00010
L=1500mm	9ABR00011
L=1000mm	9ABR00012

**ANELLO DI FISSAGGIO PER BARRA IN ALLUMINIO  
ANNEAU DE FIXATION POUR RAIL AERO EN ALUMINIUM**

**2**



CODICE - CODE
9AGAN00002

**ASTA FERMACARICHI REGOLABILE  
BARRE ARRÊT-CHARGE RÉGLABLE**

**3**



DIMENSIONI - DIMENSIONS	CODICE - CODE
L=1250-1750 mm	9AFCKIM006
L=1550-2050 mm	9AFCKIM007
L=2000-2500 mm	9AFCKIM008

**CINGHIA CON UNCINO  
SANGLE AVEC CROCHET**

**4**



DIMENSIONI - DIMENSIONS	CODICE - CODE
L=3000mm	9ACI000005

**CINGHIA CON ANELLI DI FISSAGGIO  
SANGLE AVEC ANNEAUX AERO DE FIXATION**

**5**



DIMENSIONI - DIMENSIONS	CODICE - CODE
L=3000mm	9ACI000009



**MERCEDES CITAN L1**

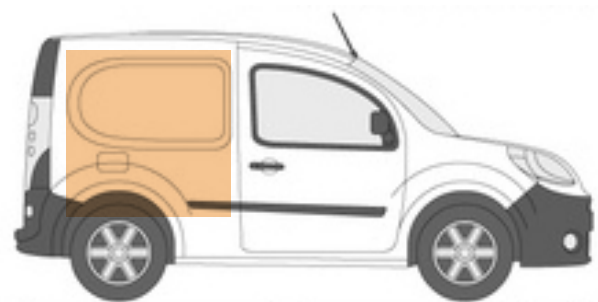

**LATO GUIDA - SINISTRO**

PASSO 2513 mm

**COTÉ CONDUCTEUR - GAUCHE**

EMPATTEMENT 2513 mm



DIMENSIONI - DIMENSIONS	CODICE - CODE
L=1014 H=955 P=360 mm	9KT1014014



DIMENSIONI - DIMENSIONS	CODICE - CODE
L=1014 H=995 P=360 mm	9KT1014015



DIMENSIONI - DIMENSIONS	CODICE - CODE
L=1014 H=1076 P=360 mm	9KT1014016



**LATO PASSEGGERO - DESTRO**

PASSO 2513 mm

**COTÉ PASSAGER - DROIT**

EMPATTEMENT 2513 mm

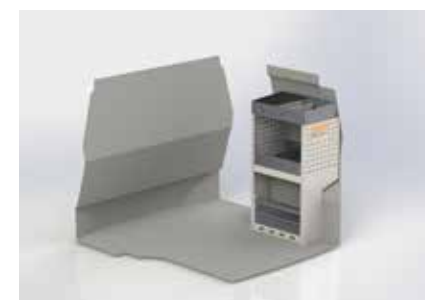

DIMENSIONI - DIMENSIONS	CODICE - CODE
L=507 H=955 P=360 mm	9KT0507004



DIMENSIONI - DIMENSIONS	CODICE - CODE
L=760 H=955 P=360 mm	9KT0760004



DIMENSIONI - DIMENSIONS	CODICE - CODE
L=760 H=995 P=360 mm	9KT0760007



**MERCEDES VITO**

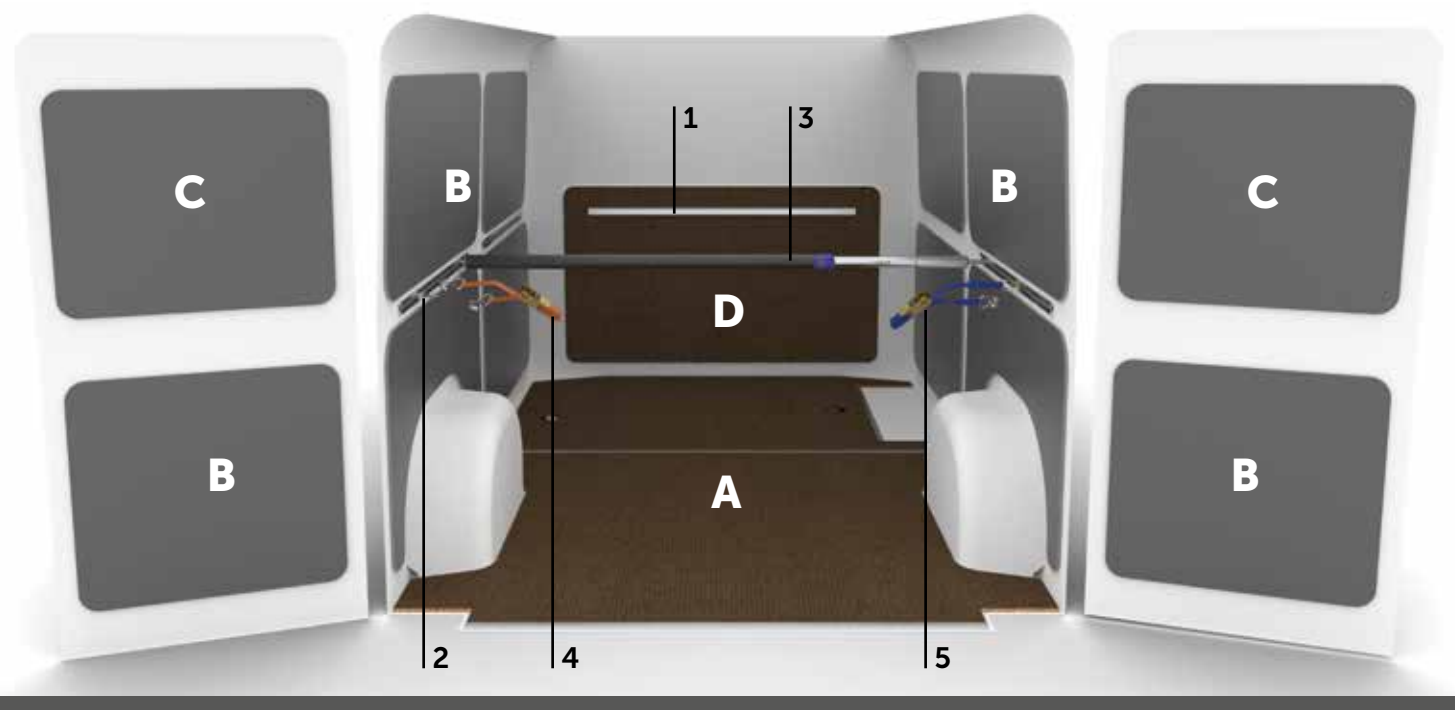

VEICOLO VÉHICULE	PIANALE PLANCHER	RIVESTIMENTO INTERNO REVÊTEMENT INTERIEUR	RIVESTIMENTO INTERNO REVÊTEMENT INTERIEUR	PARATIA DIVISORIA PAROI DE SÉPARATION
	A	B	C	D
L1 H1	9PV1432009	9RV143200P	9RV143203P	9RV1432016
L1 XL H1	9PV14320L9	9RV143201P	9RV143203P	9RV1432016
L2 H1	9PV1434009	9RV143400P	9RV143203P	9RV1432016

Preferisci una soluzione su misura per le tue esigenze? **Contattaci per un progetto personalizzato**  
Préférez-vous une solution sur mesure pour vos besoins? **Contactez-nous pour un projet personnalisé**



**PIANALI E RIVESTIMENTI - PLANCHERS ET REVÊTEMENT**

**PIANALE  
PLANCHER**

**A**



Pianale in multistrato marino sp. 9mm con rivestimento fenolico e predisposizione per gli ancoraggi originali del veicolo.

Plancher multi couche marin épaisseur 9 mm, avec revêtement phénolique et prédisposition pour les fixations d'origine du véhicule.

**RIVESTIMENTI INTERNI  
REVÊTEMENT INTERIEUR**

**B**



Pannellatura integrale in polipropilene sp. 4mm ad esclusione delle porte posteriori superiori.

Revêtement complet en polypropylène épaisseur 4 mm. sans portes arrière supérieures.

**PARATIA DIVISORIA  
ARRET DE CHARGE**

**D**

Paratia divisoria in multistrato marino con rivestimento fenolico.

Arret de charge en multi couche marin avec revêtement phénolique

**RIVESTIMENTI INTERNI  
REVÊTEMENT INTERIEUR**

**C**

Pannellatura per le porte posteriori superiori in polipropilene.

Revêtement pour les portes arrière supérieures en polypropylène.

**ACCESSORI BLOCCAGGIO MATERIALI - ACCESSOIRES POUR BLOCAGE DE MATÉRIEL**

**BARRE FERMACARICHI IN ALLUMINIO  
RAIL AERO EN ALUMINIUM**

**1**

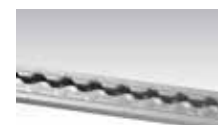

DIMENSIONI - DIMENSIONS	CODICE - CODE
L=3000mm	9ABR00009
L=2000mm	9ABR00010
L=1500mm	9ABR00011
L=1000mm	9ABR00012

**ANELLO DI FISSAGGIO PER BARRA IN ALLUMINIO  
ANNEAU DE FIXATION POUR RAIL AERO EN ALUMINIUM**

**2**



CODICE - CODE
9AGAN00002

**ASTA FERMACARICHI REGOLABILE  
BARRE ARRÊT-CHARGE RÉGLABLE**

**3**



DIMENSIONI - DIMENSIONS	CODICE - CODE
L=1250-1750 mm	9AFCKIM006
L=1550-2050 mm	9AFCKIM007
L=2000-2500 mm	9AFCKIM008

**CINGHIA CON UNCINO  
SANGLE AVEC CROCHET**

**4**



DIMENSIONI - DIMENSIONS	CODICE - CODE
L=3000mm	9ACI000005

**CINGHIA CON ANELLI DI FISSAGGIO  
SANGLE AVEC ANNEAUX AERO DE FIXATION**

**5**



DIMENSIONI - DIMENSIONS	CODICE - CODE
L=3000mm	9ACI000009



**MERCEDES VITO L1**

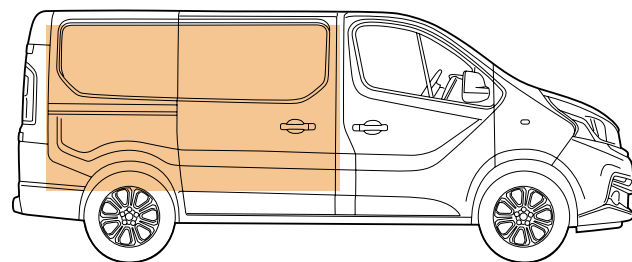

**LATO GUIDA - SINISTRO**

PASSO 3200 mm

**COTÉ CONDUCTEUR - GAUCHE**

EMPATTEMENT 3200 mm

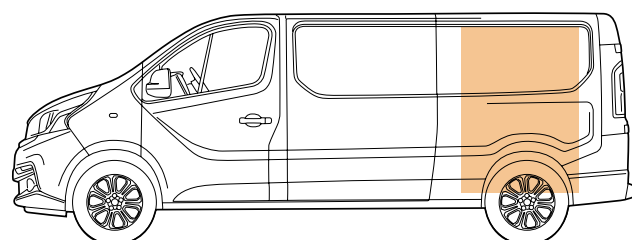

**LATO PASSEGGERO - DESTRO**

PASSO 3200 mm

**COTÉ PASSAGER - DROIT**

EMPATTEMENT 3200 mm

**MERCEDES VITO L1 XL**

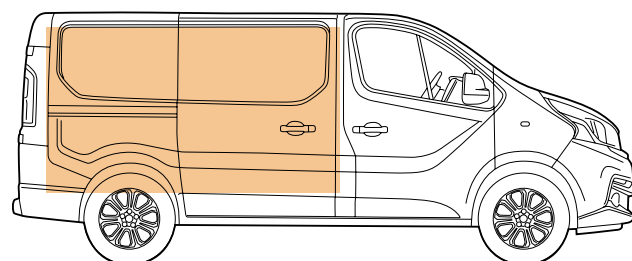

**LATO GUIDA - SINISTRO**

PASSO 3200 mm

**COTÉ CONDUCTEUR - GAUCHE**

EMPATTEMENT 3200 mm

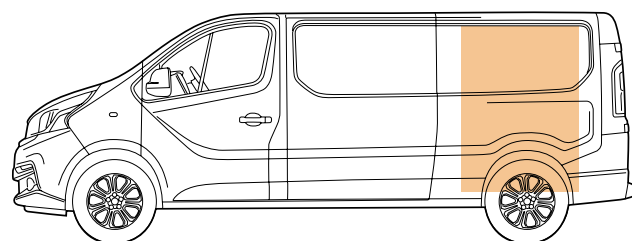

**LATO PASSEGGERO - DESTRO**

PASSO 3200 mm

**COTÉ PASSAGER - DROIT**

EMPATTEMENT 3200 mm



DIMENSIONI - DIMENSIONS	CODICE - CODE
L=1775 H=1076 P=360 mm	9KT1775001



DIMENSIONI - DIMENSIONS	CODICE - CODE
L=1775 H=1076 P=360 mm	9KT1775002



DIMENSIONI - DIMENSIONS	CODICE - CODE
L=1775 H=1307 P=360 mm	9KT1775003



DIMENSIONI - DIMENSIONS	CODICE - CODE
L=1014 H=1076 P=360 mm	9KT1014001



DIMENSIONI - DIMENSIONS	CODICE - CODE
L=1014 H=1076 P=360 mm	9KT1014002



DIMENSIONI - DIMENSIONS	CODICE - CODE
L=1014 H=1237 P=360 mm	9KT1014018



DIMENSIONI - DIMENSIONS	CODICE - CODE
L=2028 H=1196 P=360 mm	9KT2028008



DIMENSIONI - DIMENSIONS	CODICE - CODE
L=2028 H=1196 P=360 mm	9KT2028009



DIMENSIONI - DIMENSIONS	CODICE - CODE
L=2028 H=1227 P=360 mm	9KT2028010



DIMENSIONI - DIMENSIONS	CODICE - CODE
L=1268 H=1076 P=360 mm	9KT1268001



DIMENSIONI - DIMENSIONS	CODICE - CODE
L=1268 H=1227 P=360 mm	9KT1268014

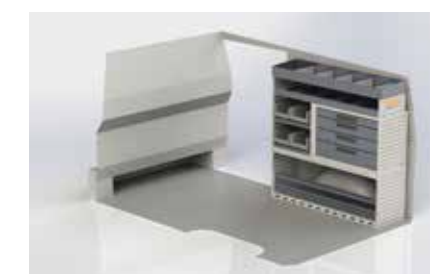

DIMENSIONI - DIMENSIONS	CODICE - CODE
L=1268 H=1227 P=360 mm	9KT1268015

**MERCEDES VITO L2**

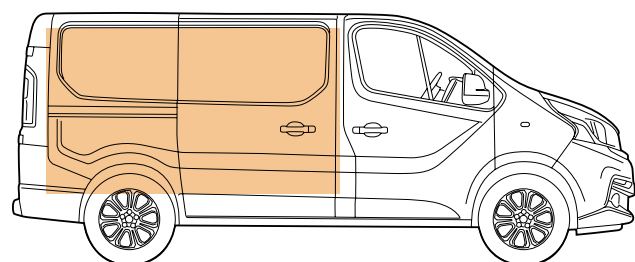

**LATO GUIDA - SINISTRO**

PASSO 3400 mm

**COTÉ CONDUCTEUR - GAUCHE**

EMPATTEMENT 3400 mm



DIMENSIONI - DIMENSIONS	CODICE - CODE
L=2282 H=1196 P=360 mm	9KT2282001



DIMENSIONI - DIMENSIONS	CODICE - CODE
L=2282 H=1076 P=360 mm	9KT2282002



DIMENSIONI - DIMENSIONS	CODICE - CODE
L=2282 H=1227 P=360 mm	9KT2282003

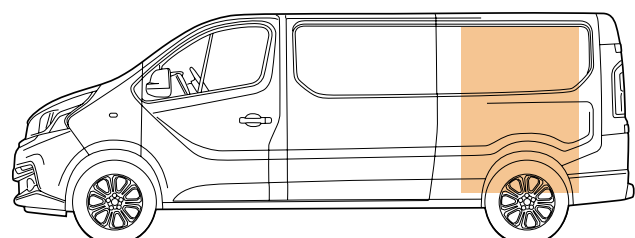

**LATO PASSEGGERO - DESTRO**

PASSO 3400 mm

**COTÉ PASSAGER - DROIT**

EMPATTEMENT 3400 mm



DIMENSIONI - DIMENSIONS	CODICE - CODE
L=1521 H=1076 P=360 mm	9KT1521018



DIMENSIONI - DIMENSIONS	CODICE - CODE
L=1521 H=1076 P=320 mm	9KT1521019



DIMENSIONI - DIMENSIONS	CODICE - CODE
L=1521 H=1076 P=360 mm	9KT1521020







**MERCEDES SPRINTER**

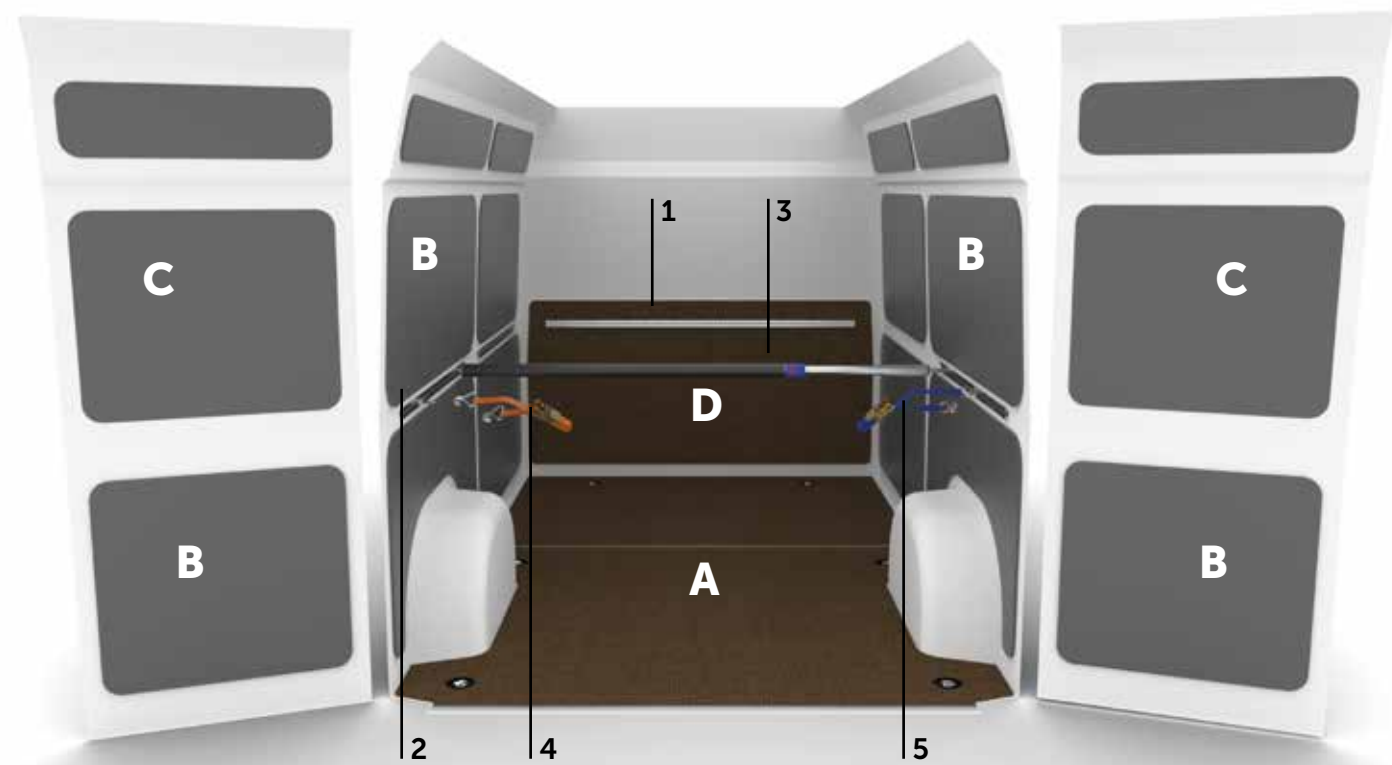

VEICOLO VÉHICULE	PIANALE PLANCHER	RIVESTIMENTO INTERNO REVÊTEMENT INTERIEUR	RIVESTIMENTO INTERNO REVÊTEMENT INTERIEUR	PARATIA DIVISORIA PAROI DE SÉPARATION
	<b>A</b>	<b>B</b>	<b>C</b>	<b>D</b>
L1 H1	9PST325009	9RST32501P	9RST32500P	9RST325016
L1 H2	9PST325009		9RST36650P	9RST325016
L2 H1	9PST366509	9RST36651P	9RST32500P	9RST325016
L2 H2	9PST366509	9RST36652P	9RST36650P	9RST325016
L3 H2	9PST432509	9RST4325P	9RST36650P	9RST325016
L3 XL H2	9PST432519	9RST43254P	9RST36650P	9RST325016

Preferisci una soluzione su misura per le tue esigenze? **Contattaci per un progetto personalizzato**  
Préférez-vous une solution sur mesure pour vos besoins? **Contactez-nous pour un projet personnalisé**



**PIANALI E RIVESTIMENTI - PLANCHERS ET REVÊTEMENT**

**PIANALE  
PLANCHER**

**A**



Pianale in multistrato marino sp. 9mm con rivestimento fenolico e predisposizione per gli ancoraggi originali del veicolo.

Plancher multi couche marin épaisseur 9 mm, avec revêtement phénolique et prédisposition pour les fixations d'origine du véhicule.

**RIVESTIMENTI INTERNI  
REVÊTEMENT INTERIEUR**

**B**



Pannellatura integrale in polipropilene sp. 4mm ad esclusione delle porte posteriori superiori.

Revêtement complet en polypropylène épaisseur 4 mm. sans portes arrière supérieures.

**PARATIA DIVISORIA  
ARRÊT DE CHARGE**

**D**

Paratia divisoria in multistrato marino con rivestimento fenolico.

Arrêt de charge en multi couche marin avec revêtement phénolique

**RIVESTIMENTI INTERNI  
REVÊTEMENT INTERIEUR**

**C**

Pannellatura per le porte posteriori superiori in polipropilene.

Revêtement pour les portes arrière supérieures en polypropylène.

**ACCESSORI BLOCCAGGIO MATERIALI - ACCESSOIRES POUR BLOCAGE DE MATÉRIEL**

**BARRE FERMACARICHI IN ALLUMINIO  
RAIL AERO EN ALUMINIUM**

**1**



DIMENSIONI - DIMENSIONS	CODICE - CODE
L=3000mm	9ABR000009
L=2000mm	9ABR000010
L=1500mm	9ABR000011
L=1000mm	9ABR000012

**ANELLO DI FISSAGGIO PER BARRA IN ALLUMINIO  
ANNEAU DE FIXATION POUR RAIL AERO EN ALUMINIUM**

**2**



CODICE - CODE
9AGAN00002

**ASTA FERMACARICHI REGOLABILE  
BARRÉ ARRÊT-CHARGE RÉGLABLE**

**3**



DIMENSIONI - DIMENSIONS	CODICE - CODE
L=1250-1750 mm	9AFCKIM006
L=1550-2050 mm	9AFCKIM007
L=2000-2500 mm	9AFCKIM008

**CINGHIA CON UNCINO  
SANGLE AVEC CROCHET**

**4**



DIMENSIONI - DIMENSIONS	CODICE - CODE
L=3000mm	9ACI000005

**CINGHIA CON ANELLI DI FISSAGGIO  
SANGLE AVEC ANNEAUX AERO DE FIXATION**

**5**



DIMENSIONI - DIMENSIONS	CODICE - CODE
L=3000mm	9ACI000009

**MERCEDES SPRINTER L1**



**LATO GUIDA - SINISTRO**

PASSO 3250 mm

**COTÉ CONDUCTEUR - GAUCHE**

EMPATTEMENT 3250 mm



DIMENSIONI - DIMENSIONS	CODICE - CODE
L=2282 H=1549 P=360 mm	9KT2282008



DIMENSIONI - DIMENSIONS	CODICE - CODE
L=2282 H=1549 P=360 mm	9KT2282009



DIMENSIONI - DIMENSIONS	CODICE - CODE
L=2282 H=1549 P=360 mm	9KT2282010



**LATO PASSEGGERO - DESTRO**

PASSO 3250 mm

**COTÉ PASSAGER - DROIT**

EMPATTEMENT 3250 mm



DIMENSIONI - DIMENSIONS	CODICE - CODE
L=1268 H=1438 P=360 mm	9KT1268016



DIMENSIONI - DIMENSIONS	CODICE - CODE
L=1268 H=1227 P=360 mm	9KT1268014



DIMENSIONI - DIMENSIONS	CODICE - CODE
L=1268 H=1560 P=360 mm	9KT1268005

**MERCEDES SPRINTER L2**

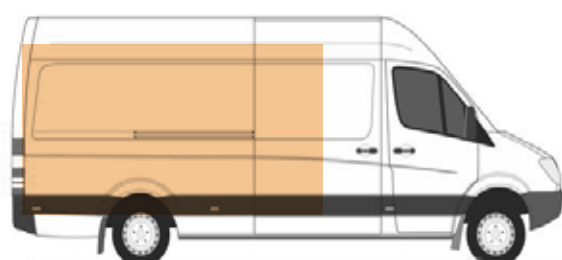

**LATO GUIDA - SINISTRO**

PASSO 3665 mm

**COTÉ CONDUCTEUR - GAUCHE**

EMPATTEMENT 3665 mm



DIMENSIONI - DIMENSIONS	CODICE - CODE
L=2535 H=1600 P=360 mm	9KT2535001



DIMENSIONI - DIMENSIONS	CODICE - CODE
L=2535 H=1680 P=360 mm	9KT2535002



DIMENSIONI - DIMENSIONS	CODICE - CODE
L=2535 H=1790 P=360 mm	9KT2535004

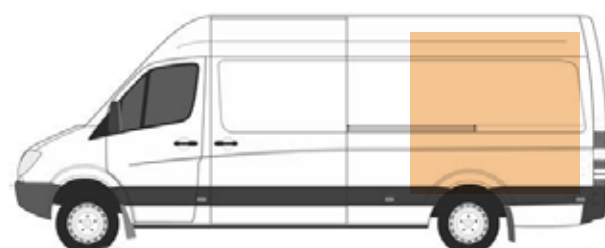

**LATO PASSEGGERO - DESTRO**

PASSO 3665 mm

**COTÉ PASSAGER - DROIT**

EMPATTEMENT 3665 mm



DIMENSIONI - DIMENSIONS	CODICE - CODE
L=1521 H=990 P=360 mm	9KT1521002



DIMENSIONI - DIMENSIONS	CODICE - CODE
L=1521 H=1560 P=360 mm	9KT1521005



DIMENSIONI - DIMENSIONS	CODICE - CODE
L=1521 H=1560 P=360 mm	9KT1521004



**MERCEDES SPRINTER L3**

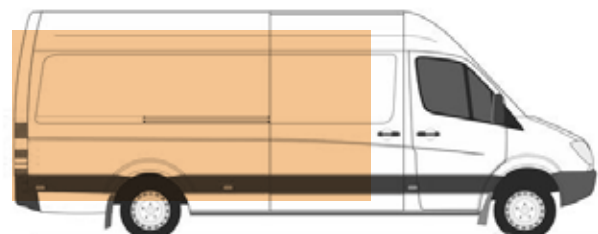

**LATO GUIDA - SINISTRO**

PASSO 4325 mm

**COTÉ CONDUCTEUR - GAUCHE**

EMPATTEMENT 4325 mm



DIMENSIONI - DIMENSIONS	CODICE - CODE
L=3802 H=1679 P=360 mm	9KT3802001



DIMENSIONI - DIMENSIONS	CODICE - CODE
L=3802 H=1679 P=360 mm	9KT3802002



DIMENSIONI - DIMENSIONS	CODICE - CODE
L=3802 H=1679 P=360 mm	9KT3802003



**LATO PASSEGGERO - DESTRO**

PASSO 4325 mm

**COTÉ PASSAGER - DROIT**

EMPATTEMENT 4325 mm

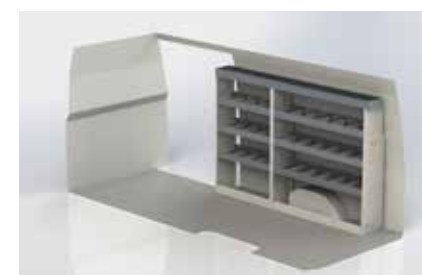

DIMENSIONI - DIMENSIONS	CODICE - CODE
L=2535 H=1669 P=360 mm	9KT2535005



DIMENSIONI - DIMENSIONS	CODICE - CODE
L=2535 H=1669 P=360 mm	9KT2535006



DIMENSIONI - DIMENSIONS	CODICE - CODE
L=2535 H=1790 P=360 mm	9KT2535007

**MERCEDES SPRINTER L3 XL**

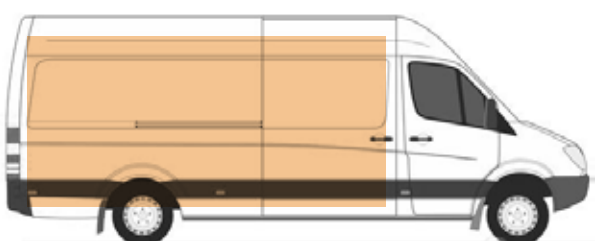

**LATO GUIDA - SINISTRO**

PASSO 4325 mm

**COTÉ CONDUCTEUR - GAUCHE**

EMPATTEMENT 4325 mm



DIMENSIONI - DIMENSIONS	CODICE - CODE
L=4310 H=1669 P=360 mm	9KT4310001



DIMENSIONI - DIMENSIONS	CODICE - CODE
L=4310 H=1709 P=360 mm	9KT4310002



DIMENSIONI - DIMENSIONS	CODICE - CODE
L=4310 H=1709 P=360 mm	9KT4310003



**LATO PASSEGGERO - DESTRO**

PASSO 4325 mm

**COTÉ PASSAGER - DROIT**

EMPATTEMENT 4325 mm



DIMENSIONI - DIMENSIONS	CODICE - CODE
L=2788 H=1679 P=360 mm	9KT2788001



DIMENSIONI - DIMENSIONS	CODICE - CODE
L=2788 H=1679 P=360 mm	9KT2788002



DIMENSIONI - DIMENSIONS	CODICE - CODE
L=2788 H=1709 P=360 mm	9KT2788003

**SCAFFALATURA EXPRESS**

Siamo lieti di presentarvi il nuovo sistema di SCAFFALATURE EXPRESS. Tale sistema è stato progettato per trasportare prodotti di tutte le dimensioni. Con semplici gesti potrete adattare la scaffalatura a qualsiasi tipo di carico. Questa soluzione si adatta in particolar modo come allestimento per servizi pacchi come ad esempio DPD, DHL, UPS, GLS etc., dal momento che ottimizza il vano di carico ed assicura il trasporto di colli grandi e piccoli così come di merce voluminosa. **IMPORTANTE:** Per l'installazione delle scaffalature Express è necessaria la paratia divisoria tra il vano di carico e il vano passeggeri.

**ÉTAGERES EXPRESS**

Le système de rangement ETAGERES EXPRESS ORDER SYSTEM convient parfaitement aux entreprises de transport de colis ou matériel maintenance. Ces étagères ont été conçues pour transporter n'importe quel colis en toute sécurité. En effet, en quelques mouvements, l'étagère s'adapte à vos exigences de transport : En position horizontale, l'étagère devient pratique et sûre pour le transport des paquets de petites ou moyennes tailles. Une fois repliée le long de la paroi, l'étagère offre ainsi un espace de chargement pour les colis de grandes tailles et volumineux. Légère, résistante aux chocs et modulable, l'étagère Express est le système d'aménagement le plus sûr et le plus avantageux pour la personne en charge des livraisons. Elle peut ainsi optimiser et utiliser au maximum la zone de chargement, tout en augmentant la sécurité des hommes et du matériel transporté sur la route. **CONSEIL IMPORTANT:** l'installation du système ETAGERES EXPRESS nécessite un cloison de séparation entre le compartiment de chargement et la cabine de conduite.





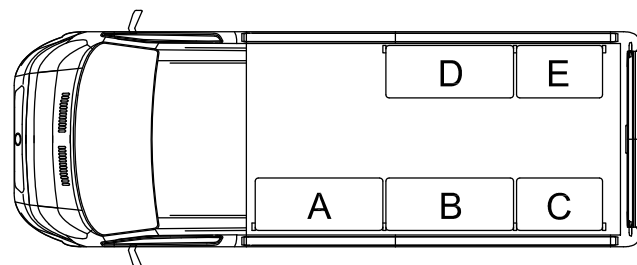
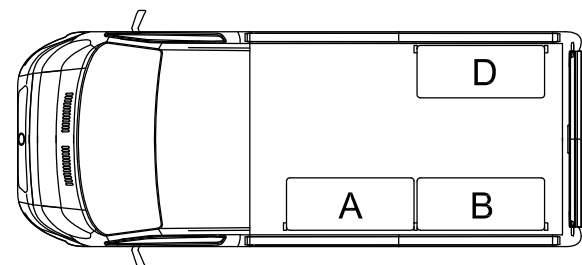

Veicolo Véhicule	Passo Empattement	Tetto Hauteur	H Montanti H Montants	Larghezza Ripiani Largeur Plateau				
				A	B	C	D	E
SPRINTER 2006	L1 3250	H1	1515	1025	1025		1025	
	L2 3665	H2	1725	1225	1625		1525	
	L2 3665	H3	1725	1225	1625		1525	
MERCEDES VITO 2003	L1 3200	H1	1305	1025	825		825	
	L1 XL 3200	H1	1305	1025	1025		1225	
	L1 XL 3200	H2	1725	1025	1025		1225	
	L2 3400	H1	1305	1225	825		1525	

**EXP 001**

LATO SINISTRO L X P X H	PESO KG	LATO DESTRO L X P X H
1978 x 500 x 1305	42,90	904 x 500 x 1305

- 2 ripiani L=825 / 2 étagères L=825
- 1 ripiano L=1025 / 1 étagère L=1025

LATO SINISTRO - COTÉ GAUCHE | LATO DESTRO - COTÉ DROIT

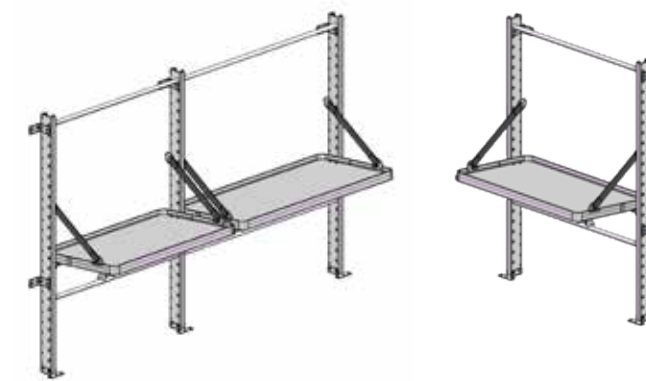

**EXP 002**

LATO SINISTRO L X P X H	PESO KG	LATO DESTRO L X P X H
2372 x 500 x 1725	80,70	1104 x 500 x 1725

- 4 ripiani L=1025 / 4 étagères L=1025
- 2 ripiani L=1225 / 2 étagères L=1225

LATO SINISTRO - COTÉ GAUCHE | LATO DESTRO - COTÉ DROIT

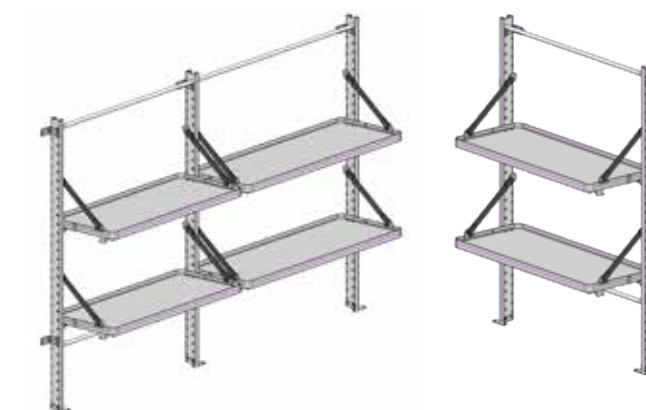

**EXP 003**

LATO SINISTRO L X P X H	PESO KG	LATO DESTRO L X P X H
2372 x 500 x 1830	84,45	1304 x 500 x 1830

- 4 ripiani L=1025 / 4 étagères L=1025
- 2 ripiani L=1225 / 2 étagères L=1225

LATO SINISTRO - COTÉ GAUCHE | LATO DESTRO - COTÉ DROIT

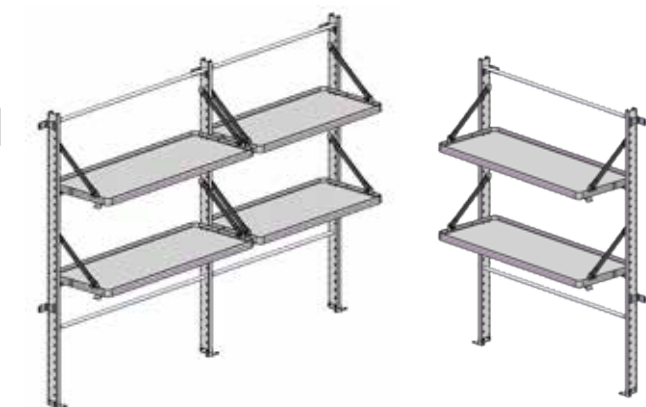

MODELLO	ANNO	EXP001	EXP002	EXP003
MERCEDES				
VITO L1 XL H1	2003	•		
SPRINTER L2 H2	2006		•	

MODELLO - MODÈLE | ANNO - ANNÉE



**SELLA PORTACAVI  
SUPPORT DE CABLES**

DIMENSIONI - DIMENSIONS	CODICE - CODE
190x130x70mm	9SP0000022
260x200x110mm	9SP0000026
340x240x240mm	9SP0000032

Struttura in alluminio che permette di sorreggere cavi e può essere fissata sia nei moduli Order sia sul furgone.  
Structure en aluminium peint qui permet de supporter des câbles. Il peut être fixé aux modules ORDER ou directement sur le véhicule.



**PORTAROTOLO  
DÉROULEUR DE PAPIER**

DIMENSIONI - DIMENSIONS	DIMENSIONI CARTA - TAILLE DE PAPIER	CODICE - CODE
250x130x170mm	Ø 150 mm	9APC000002
270x170x260mm	Ø 200 mm	9APC000001

Struttura in alluminio verniciato a polveri, dotato di sistema che impedisce lo srotolamento della carta.  
Structure en aluminium peint doté d'un système empêchant le papier de se dérouler.



**DOSATORE LAVAMANI 1000 ML  
DOSEUR POUR SAVON 1000 ML**

DIMENSIONI - DIMENSIONS	CODICE - CODE
108X275X104mm	9ADS000001



**TASCHE IN ALLUMINIO  
PORTE-DOCUMENTS EN ALUMINIUM**

DIMENSIONI - DIMENSIONS	CODICE - CODE
220X240X40mm	9ATA400000



**PLAFONIERA AL LED 240 LUMEN 12V  
PLAFONNIER À LED 240 LUMENS 12V**

DIMENSIONI - DIMENSIONS	CODICE - CODE
360X9X25mm	9APLED0063
590X9X25mm	9APLED0064



**PORTA TANICA CON TANICA IN PLASTICA 10L  
PORTE-JERRYCAN ET JERRYCAN PLASTIQUE 10L**

DIMENSIONI - DIMENSIONS	CODICE - CODE
318X340X158mm	9APTNO0002

Portatanica con tanica in plastica con pratico rubinetto che permette di regolare il flusso dell'acqua.  
Porte-jerrycan et jerrycan plastique avec robinet permettant de réguler le débit de l'eau.



**PORTA TANICA CON TANICA IN FERRO 20L  
PORTE-JERRYCAN AVEC JERRYCAN EN FER 20L**

DIMENSIONI - DIMENSIONS	CODICE - CODE
351X472X175mm	9APTNO0002

Portatanica in alluminio compreso di tanica in ferro da 20L adatta per il trasporto di oli o carburanti.  
Porte-jerrycan en aluminium et jerrycan en fer (20L) pour transport d'huile ou de carburant.



**PORTATANICA +TANICA CARBURANTI IN PLASTICA LT.10  
PORTE-JERRYCAN AVEC JERRYCAN EN PLASTIQUE 10L POUR CARBURANT**

DIMENSIONI - ABMESSUNGEN	CODE - CODE
315X312X191mm	9APTNO0003

Portatanica in alluminio con tanica in plastica da 10L adatta per il trasporto di oli o carburanti.  
Porte-jerrycan en aluminium et jerrycan en fer (20L) pour transport d'huile ou de carburant.

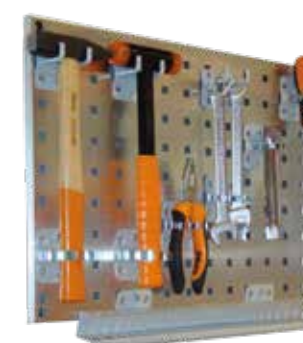

**PANNELLO FORATO PORTAUTENSILI CON KIT DI 10 GANCI  
PANNEAU PERCÉ PORTE-OUTILLAGE AVEC KIT DE 10 CROCHETS**

DIMENSIONI - DIMENSIONS	CODICE - CODE
360X483X10mm	9APFFG4836





**CASSETTA PRIMO SOCCORSO**  
**MALLETE DE PREMIERS SECOURS**

DIMENSIONI - DIMENSIONS	CODICE - CODE
340x240x240mm	9ACP000001



**BARRA FERMACARICO IN ACCIAIO CON CINGHIA**  
**RAIL UNIVERSEL EN ALUMINIUM AVEC SANGLE**

DIMENSIONI - DIMENSIONS	CODICE - CODE
L 360 + L 600 mm	9ABF000001



**MENSOLA PORTA SILICONI**  
**ÉTAGÈRE PORTE BOMBES SILICONES**

DIMENSIONI - DIMENSIONS	CODICE - CODE
Ø 50 mm	9APSIL0360



**MENSOLA PORTA BOMBOLETTE Ø70 mm PER PANNELLO FORATO**  
**TABLETTE PORTE-BOMBE DE SPRAY Ø70 mm POUR PANNEAU PERCÉ**

DIMENSIONI - DIMENSIONS	CODICE - CODE
283x74x87 mm	9AGPF23176

**CENTRI SPECIALIZZATI IN TUTTA EUROPA**

Installazione ed assistenza

**CENTRES SPECIALISÉS DANS TOUTE EUROPE**

Installation et assistance

**CONTATTA IL PUNTO DI ALLESTIMENTO PIU' VICINO:**

**VEUILLEZ CONTACTER LE CENTRE DE POSE LE PLUS PROCHE DE CHEZ VOUS :**

[www.ordersystem.it](http://www.ordersystem.it)

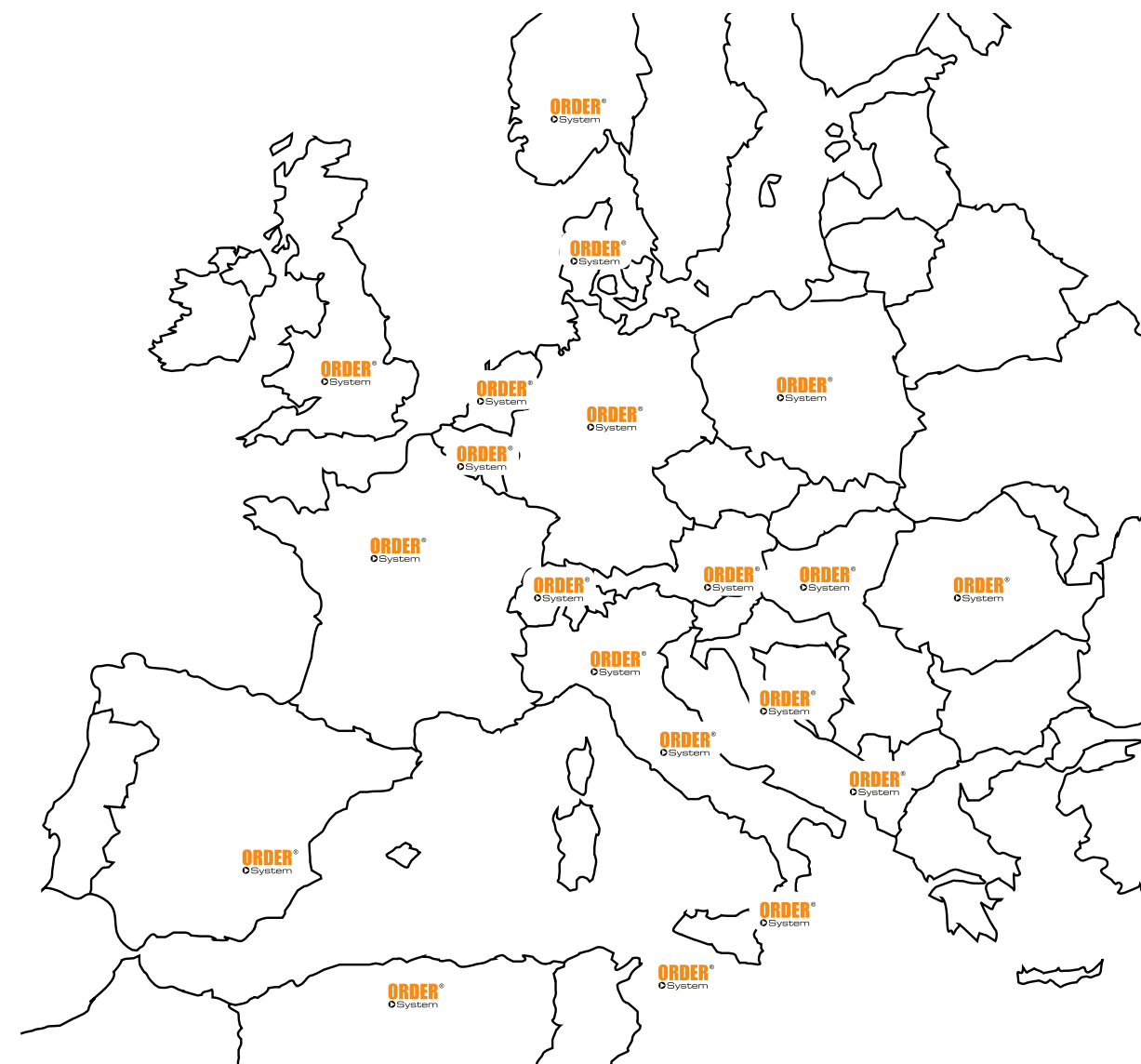



**TECNO A srl.**

Via del Lavoro, 4  
Loc. Canavaccio 61029 Urbino PU ITALY

**T. +39 0722 354048 F. +39 0722 354049**

**info@ordersystem.it**

TIMBRO DEL RIVENDITORE - CACHET DU DISTRIBUTEUR: