



Ordine in movimento
L'Ordine en mouvement

L'Évolution dell'allestimento per veicoli commerciali
L'Évolution de l'aménagement pour VUL



Allestimento automezzi
Aménagement de véhicules utilitaires



Company Tecno A Italy

Production Tecno A Italy

Order System nel mondo, un partner affidabile in efficienza e sicurezza.

Order System è un produttore di allestimenti conosciuto in tutto il mondo per la sua qualità, funzionalità e flessibilità.

Order System, dans le monde, un partenaire fiable pour l'efficacité et la sécurité.

Order System, est un fabricant dont les matériels sont connus mondialement pour leur qualité, leur fonctionnalité et leur flexibilité.

OUR CERTIFICATIONS



FLOORS / PLANCHERS



LININGS / HABILLAGES



CRASH TEST



CRASH TEST



RAMPS / RAMPES



LADDER RACKS / ETAGÈRES

LAVORARE E GUIDARE IN SICUREZZA

Tecno A S.r.l. ha eseguito un nuovo crash test per gli allestimenti Order System®, alla velocità di 60 km/h e ha superato brillantemente la prova al primo tentativo dimostrando la qualità del prodotto. Il crash test è stato eseguito in Francia presso VALUTEC S.A. dipartimento C3T (Centro Tecnologico in Trasporti Terrestri). Order System® tiene molto alla salute e alla sicurezza dei suoi clienti.

TRAVAILLER ET CONDUIRE EN TOUTE SÉCURITÉ

TECNO A S.r.l a réalisé un nouveau crash-test pour les équipements de véhicules utilitaires Order System® à une vitesse de 60km/h et a réussi ce test avec succès au premier essai, en démontrant la qualité de ses produits. Le crash-test a été réalisé en France chez VALUTEC S.A. au département C3T (Centre Technologique de Transport Terrestre). Order System® prête toute son attention à la santé et la sécurité de ses clients.



BEFORE / AVANT



AFTER / APRES





SISTEMA QUALITÀ CERTIFICATA ISO 9001

SYSTÈME QUALITÉ CERTIFIÉ ISO 9001

GARANZIA 3 ANNI Il materiale Order System® dal momento in cui è montato ha una garanzia di 3 anni per i difetti di costruzione.

GARANTIE 3 ANS Les produits Order System® bénéficient d'une garantie de 3 ans (contre tout défaut ou vice de fabrication) à compter de la date d'installation.

FINANZIABILITÀ Il materiale Order System® può essere inserito senza problemi nel finanziamento d'acquisto del vostro veicolo.

FINANCEMENT Les produits Order System® peuvent être intégrés au financement de votre utilitaire.



Ordine in movimento
L'Ordre en mouvement

OPEL COMBO

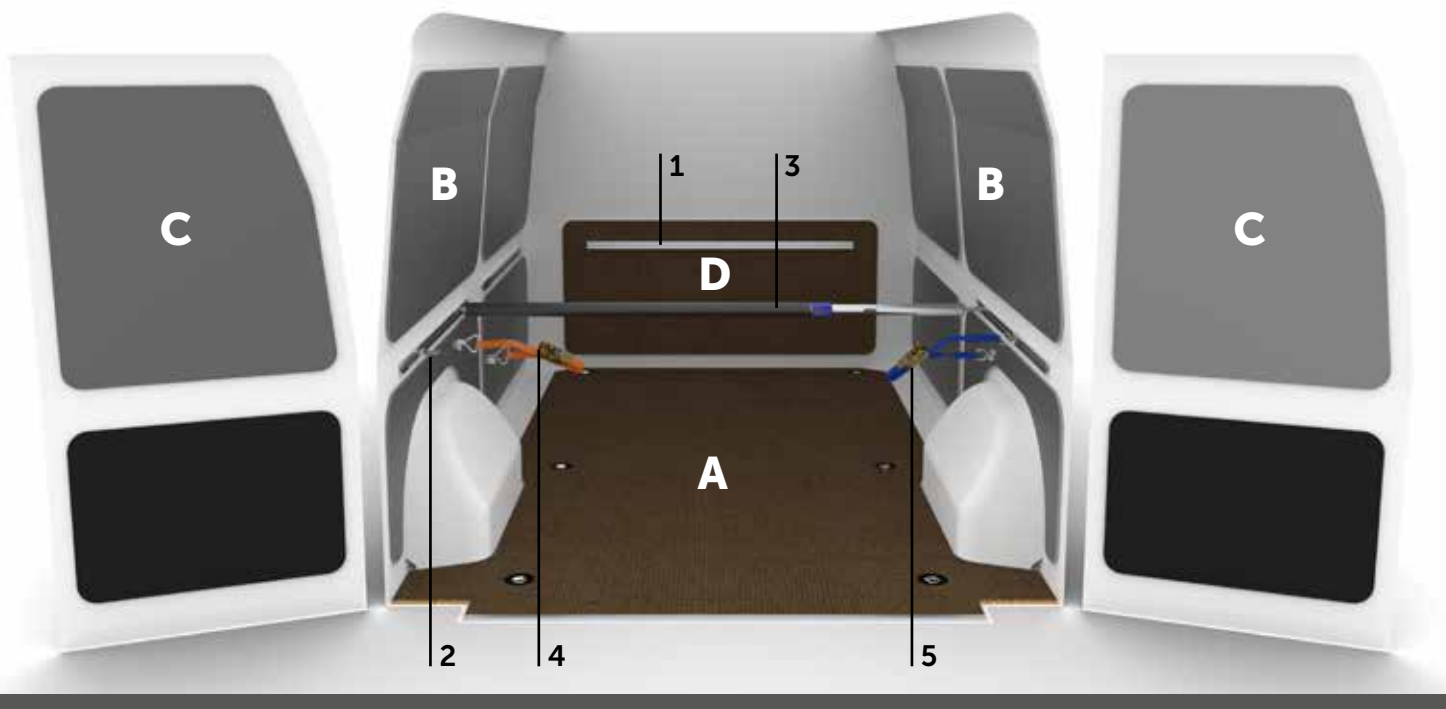

VEICOLO VÉHICULE	PIANALE PLANCHER	RIVESTIMENTO INTERNO REVÊTEMENT INTERIEUR	RIVESTIMENTO INTERNO REVÊTEMENT INTERIEUR	PARATIA DIVISORIA ARRET DE CHARGE
	A	B	C	D
L1 H1	9PDL275509	9RDL27551P	9RDL20100P	9RDL201016
L2 H1	9PDL310509	9RDL31052P	9RDL20100P	9RDL201016

Preferisci una soluzione su misura per le tue esigenze? **Contattaci per un progetto personalizzato**
Préférez-vous une solution sur mesures? **Contactez-nous pour un projet personnalisé**



PIANALI E RIVESTIMENTI - PLANCHERS ET REVÊTEMENT

PIANALE PLANCHER

A



Pianale in multistrato marino sp. 9mm con rivestimento fenolico e predisposizione per gli ancoraggi originali del veicolo.

Plancher multi couche marin épaisseur 9 mm, avec revêtement phénolique et prédisposition pour les fixations d'origine du véhicule.

RIVESTIMENTI INTERNI REVÊTEMENT INTERIEUR

B



Pannellatura integrale in polipropilene sp. 4mm ad esclusione delle porte posteriori superiori.

Revêtement complet en polypropylène épaisseur 4 mm. sans portes arrière supérieures.

PARATIA DIVISORIA ARRET DE CHARGE

D

Paratia divisoria in multistrato marino con rivestimento fenolico.

Arret de charge en multi couche marin avec revêtement phénolique

RIVESTIMENTI INTERNI REVÊTEMENT INTERIEUR

C

Pannellatura per le porte posteriori superiori in polipropilene.

Revêtement pour les portes arrière supérieures en polypropylène.

ACCESSORI BLOCCAGGIO MATERIALI - ACCESSOIRES POUR BLOCAGE DE MATÉRIEL

BARRE FERMACARICHI IN ALLUMINIO RAIL AERO EN ALUMINIUM

1

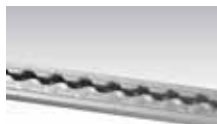

DIMENSIONI - DIMENSIONS	CODICE - CODE
L=3000mm	9ABR00009
L=2000mm	9ABR00010
L=1500mm	9ABR00011
L=1000mm	9ABR00012

ANELLO DI FISSAGGIO PER BARRA IN ALLUMINIO ANNEAU DE FIXATION POUR RAIL AERO EN ALUMINIUM

2



CODICE - CODE

9AGAN00002

ASTA FERMACARICHI REGOLABILE BARRE ARRÊT-CHARGE RÉGLABLE

3



DIMENSIONI - DIMENSIONS	CODICE - CODE
L=1250-1750 mm	9AFCKIM006
L=1550-2050 mm	9AFCKIM007
L=2000-2500 mm	9AFCKIM008

CIGHIA CON UNCINO SANGLE AVEC CROCHET

4



DIMENSIONI - DIMENSIONS

L=3000mm

CODICE - CODE

9ACI000005

CIGHIA CON ANELLI DI FISSAGGIO SANGLE AVEC ANNEAUX AERO DE FIXATION

5



DIMENSIONI - DIMENSIONS

L=3000mm

CODICE - CODE

9ACI000009

OPEL COMBO L1

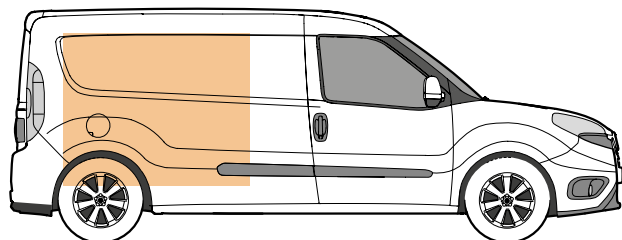

LATO GUIDA - SINISTRO

PASSO 2755 mm

COTÉ CONDUCTEUR - GAUCHE

EMPATTEMENT 2755 mm

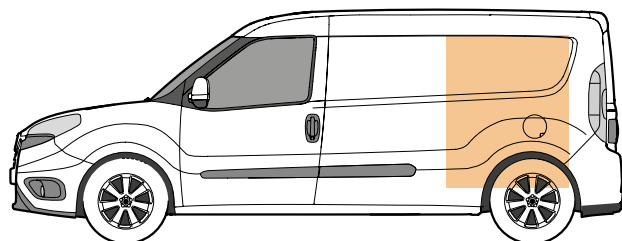

LATO PASSEGGERO - DESTRO

PASSO 2755 mm

COTÉ PASSAGER - DROIT

EMPATTEMENT 2755 mm

OPEL COMBO L2

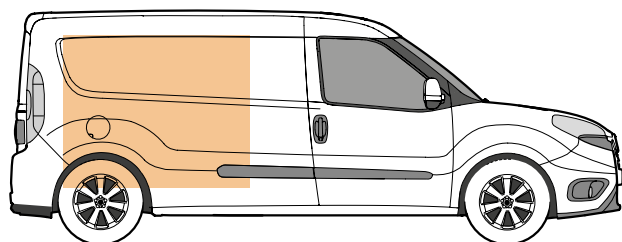

LATO GUIDA - SINISTRO

PASSO 3105 mm

COTÉ CONDUCTEUR - GAUCHE

EMPATTEMENT 3105 mm

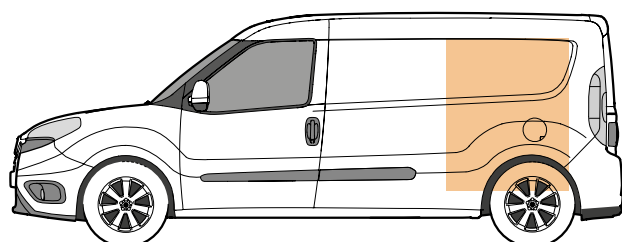

LATO PASSEGGERO - DESTRO

PASSO 3105 mm

COTÉ PASSAGER - DROIT

EMPATTEMENT 3105 mm



DIMENSIONI - DIMENSIONS	CODICE - CODE
L=1268 H=1076 P=360 mm	9KT1268010



DIMENSIONI - DIMENSIONS	CODICE - CODE
L=1268 H=1076 P=360 mm	9KT1268011



DIMENSIONI - DIMENSIONS	CODICE - CODE
L=1268 H=1076 P=360 mm	9KT1268012



DIMENSIONI - DIMENSIONS	CODICE - CODE
L=760 H=1076 P=360 mm	9KT0760005



DIMENSIONI - DIMENSIONS	CODICE - CODE
L=760 H=1076 P=360 mm	9KT0760006



DIMENSIONI - DIMENSIONS	CODICE - CODE
L=760 H=1076 P=360 mm	9KT0760008



DIMENSIONI - DIMENSIONS	CODICE - CODE
L=1521 H=1076 P=360 mm	9KT1521009



DIMENSIONI - DIMENSIONS	CODICE - CODE
L=1521 H=1076 P=360 mm	9KT1521010



DIMENSIONI - DIMENSIONS	CODICE - CODE
L=1521 H=1076 P=360 mm	9KT1521011



DIMENSIONI - DIMENSIONS	CODICE - CODE
L=1014 H=1076 P=360 mm	9KT1014012



DIMENSIONI - DIMENSIONS	CODICE - CODE
L=1014 H=1076 P=360 mm	9KT1014013



DIMENSIONI - DIMENSIONS	CODICE - CODE
L=1014 H=1076 P=360 mm	9KT1014017

OPEL VIVARO

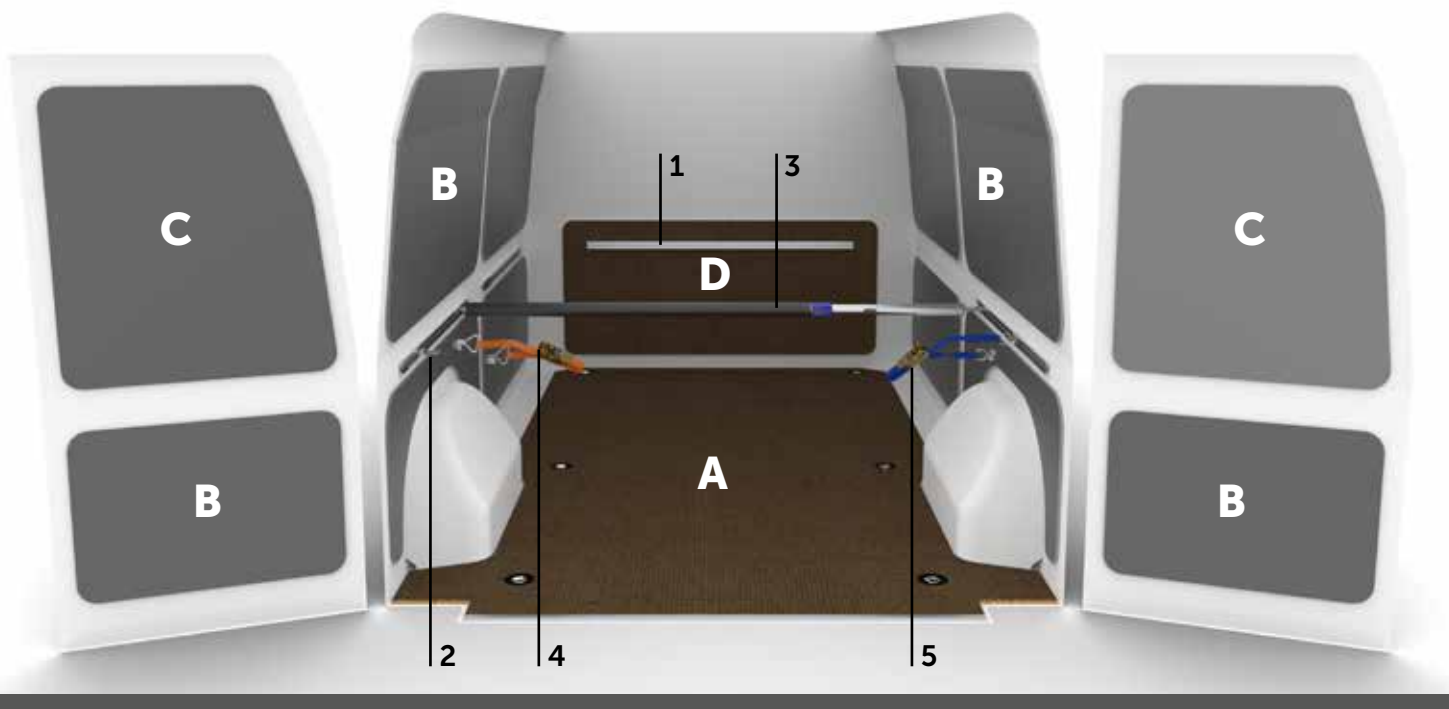

VEICOLO VÉHICULE	PIANALE PLANCHER	RIVESTIMENTO INTERNO REVÊTEMENT INTERIEUR	RIVESTIMENTO INTERNO REVÊTEMENT INTERIEUR	PARATIA DIVISORIA ARRET DE CHARGE
	A	B	C	D
L1 H1	9PT1430989	9RT143091P	9RT140001P	9RT1400016
L2 H1	9PT1434989	9RT143491P	9RT140001P	9RT1400016



Preferisci una soluzione su misura per le tue esigenze? **Contattaci per un progetto personalizzato**
Préférez-vous une solution sur mesure pour vos besoins? **Contactez-nous pour un projet personnalisé**

PIANALI E RIVESTIMENTI - PLANCHERS ET REVÊTEMENT

PIANALE PLANCHER

A



Pianale in multistrato marino sp. 9mm con rivestimento fenolico e predisposizione per gli ancoraggi originali del veicolo.

Plancher multi couche marin épaisseur 9 mm, avec revêtement phénolique et prédisposition pour les fixations d'origine du véhicule.

RIVESTIMENTI INTERNI REVÊTEMENT INTERIEUR

B



Pannellatura integrale in polipropilene sp. 4mm ad esclusione delle porte posteriori superiori.

Revêtement complet en polypropylène épaisseur 4 mm. sans portes arrière supérieures.

PARATIA DIVISORIA ARRET DE CHARGE

D

Paratia divisoria in multistrato marino con rivestimento fenolico.

Arret de charge en multi couche marin avec revêtement phénolique

RIVESTIMENTI INTERNI REVÊTEMENT INTERIEUR

C

Pannellatura per le porte posteriori superiori in polipropilene.

Revêtement pour les portes arrière supérieures en polypropylène.

ACCESSORI BLOCCAGGIO MATERIALI - ACCESSOIRES POUR BLOCAGE DE MATÉRIEL

BARRE FERMACARICHI IN ALLUMINIO RAIL AERO EN ALUMINIUM

1

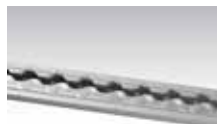

DIMENSIONI - DIMENSIONS	CODICE - CODE
L=3000mm	9ABR00009
L=2000mm	9ABR00010
L=1500mm	9ABR00011
L=1000mm	9ABR00012

ANELLO DI FISSAGGIO PER BARRA IN ALLUMINIO ANNEAU DE FIXATION POUR RAIL AERO EN ALUMINIUM

2



CODICE - CODE

9AGAN00002

ASTA FERMACARICHI REGOLABILE BARRE ARRÊT-CHARGE RÉGLABLE

3



DIMENSIONI - DIMENSIONS	CODICE - CODE
L=1250-1750 mm	9AFCKIM006
L=1550-2050 mm	9AFCKIM007
L=2000-2500 mm	9AFCKIM008

CIGHIA CON UNCINO SANGLE AVEC CROCHET

4



DIMENSIONI - DIMENSIONS

L=3000mm

CODICE - CODE

9ACI000005

CIGHIA CON ANELLI DI FISSAGGIO SANGLE AVEC ANNEAUX AERO DE FIXATION

5



DIMENSIONI - DIMENSIONS

L=3000mm

CODICE - CODE

9ACI000009

OPEL VIVARO L1

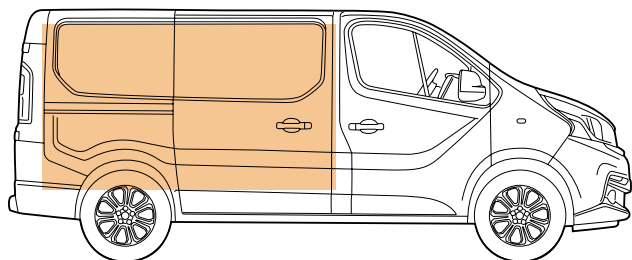

LATO GUIDA - SINISTRO

PASSO 3098 mm

COTÉ CONDUCTEUR - GAUCHE

EMPATTEMENT 3098 mm

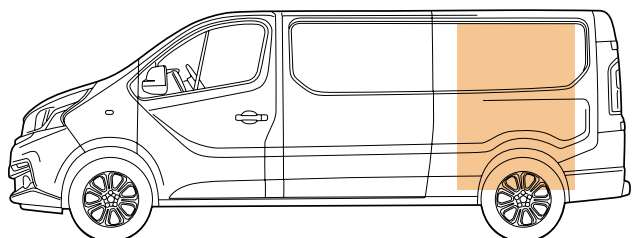

LATO PASSEGGERO - DESTRO

PASSO 3098 mm

COTÉ PASSAGER - DROIT

EMPATTEMENT 3098 mm

OPEL VIVARO L2

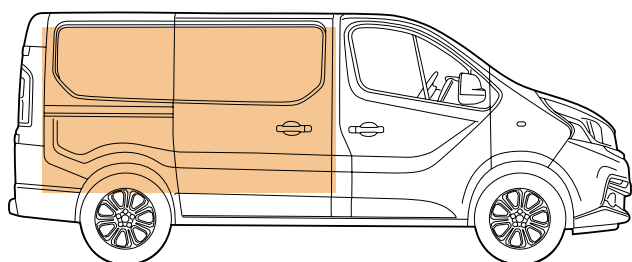

LATO GUIDA - SINISTRO

PASSO 3498 mm

COTÉ CONDUCTEUR - GAUCHE

EMPATTEMENT 3498 mm

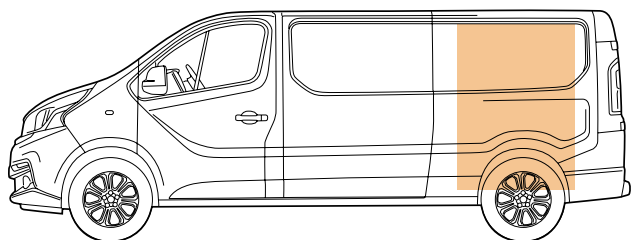

LATO PASSEGGERO - DESTRO

PASSO 3498 mm

COTÉ PASSAGER - DROIT

EMPATTEMENT 3498 mm



DIMENSIONI - DIMENSIONS	CODICE - CODE
L=1775 H=1076 P=360 mm	9KT1775001



DIMENSIONI - DIMENSIONS	CODICE - CODE
L=1775 H=1076 P=360 mm	9KT1775002



DIMENSIONI - DIMENSIONS	CODICE - CODE
L=1775 H=1307 P=360 mm	9KT1775003



DIMENSIONI - DIMENSIONS	CODICE - CODE
L=1014 H=1076 P=360 mm	9KT1014001



DIMENSIONI - DIMENSIONS	CODICE - CODE
L=1014 H=1076 P=360 mm	9KT1014002



DIMENSIONI - DIMENSIONS	CODICE - CODE
L=1014 H=1237 P=360 mm	9KT1014018



DIMENSIONI - DIMENSIONS	CODICE - CODE
L=2282 H=1196 P=360 mm	9KT2282001



DIMENSIONI - DIMENSIONS	CODICE - CODE
L=2282 H=1076 P=360 mm	9KT2282002



DIMENSIONI - DIMENSIONS	CODICE - CODE
L=2282 H=1227 P=360 mm	9KT2282003



DIMENSIONI - DIMENSIONS	CODICE - CODE
L=1268 H=1076 P=360 mm	9KT1268001



DIMENSIONI - DIMENSIONS	CODICE - CODE
L=1268 H=1227 P=360 mm	9KT1268014



DIMENSIONI - DIMENSIONS	CODICE - CODE
L=1268 H=1227 P=360 mm	9KT1268015



OPEL MOVANO

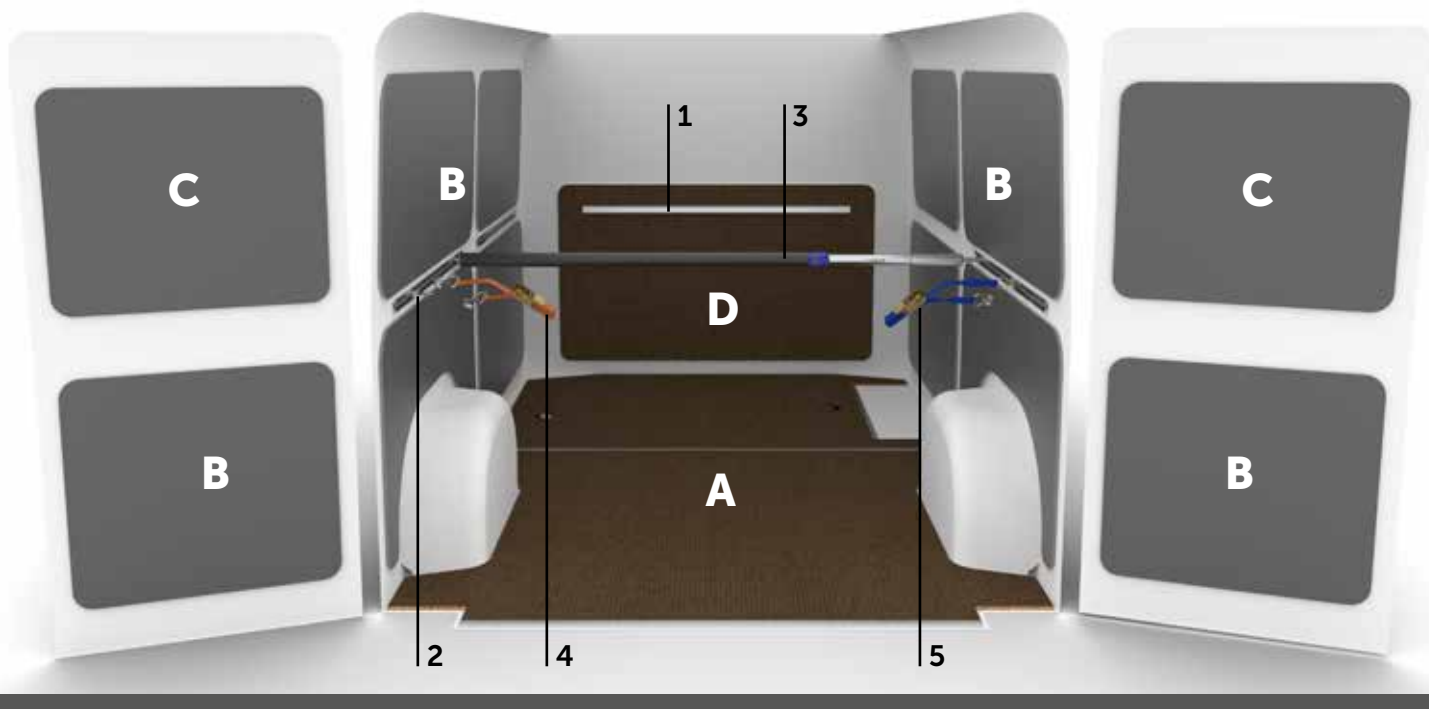

VEICOLO VÉHICULE	PIANALE PLANCHER	RIVESTIMENTO INTERNO REVÊTEMENT INTERIEUR	RIVESTIMENTO INTERNO REVÊTEMENT INTERIEUR	PARATIA DIVISORIA ARRET DE CHARGE
	A	B	C	D
L1 H1	9PMT318209	9RMT31821P	9RMT20101P	9RMT201026
L1 H2	9PMT318209	9RMT31822P	9RMT20102P	9RMT201026
L2 H2	9PMT388209	9RMT38822P	9RMT20102P	9RMT201026
L2 H3	9PMT388209	9RMT38822P	9RMT20103P	9RMT201026
L3 H2	9PMT433209	9RMT43322P	9RMT20102P	9RMT201026
L3 H3	9PMT433209	9RMT43322P	9RMT20103P	9RMT201026



Preferisci una soluzione su misura per le tue esigenze? **Contattaci per un progetto personalizzato**
Préférez-vous une solution sur mesure pour vos besoins? **Contactez-nous pour un projet personnalisé**

PIANALI E RIVESTIMENTI - PLANCHERS ET REVÊTEMENT

PIANALE PLANCHER

A



Pianale in multistrato marino sp. 9mm con rivestimento fenolico e predisposizione per gli ancoraggi originali del veicolo.

Plancher multi couche marin épaisseur 9 mm, avec revêtement phénolique et prédisposition pour les fixations d'origine du véhicule.

RIVESTIMENTI INTERNI REVÊTEMENT INTERIEUR

B



Pannellatura integrale in polipropilene sp. 4mm ad esclusione delle porte posteriori superiori.

Revêtement complet en polypropylène épaisseur 4 mm. sans portes arrière supérieures.

PARATIA DIVISORIA ARRET DE CHARGE

D

Paratia divisoria in multistrato marino con rivestimento fenolico.

Arret de charge en multi couche marin avec revêtement phénolique

RIVESTIMENTI INTERNI REVÊTEMENT INTERIEUR

C

Pannellatura per le porte posteriori superiori in polipropilene.

Revêtement pour les portes arrière supérieures en polypropylène.

ACCESSORI BLOCCAGGIO MATERIALI - ACCESSOIRES POUR BLOCAGE DE MATÉRIEL

BARRE FERMACARICHI IN ALLUMINIO RAIL AERO EN ALUMINIUM

1

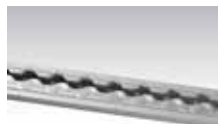

DIMENSIONI - DIMENSIONS	CODICE - CODE
L=3000mm	9ABR00009
L=2000mm	9ABR00010
L=1500mm	9ABR00011
L=1000mm	9ABR00012

ANELLO DI FISSAGGIO PER BARRA IN ALLUMINIO ANNEAU DE FIXATION POUR RAIL AERO EN ALUMINIUM

2



CODICE - CODE

9AGAN00002

ASTA FERMACARICHI REGOLABILE BARRE ARRÊT-CHARGE RÉGLABLE

3



DIMENSIONI - DIMENSIONS	CODICE - CODE
L=1250-1750 mm	9AFCKIM006
L=1550-2050 mm	9AFCKIM007
L=2000-2500 mm	9AFCKIM008

CIGHIA CON UNCINO SANGLE AVEC CROCHET

4



DIMENSIONI - DIMENSIONS

L=3000mm

CODICE - CODE

9ACI000005

CIGHIA CON ANELLI DI FISSAGGIO SANGLE AVEC ANNEAUX AERO DE FIXATION

5



DIMENSIONI - DIMENSIONS

L=3000mm

CODICE - CODE

9ACI000009

OPEL MOVANO L1

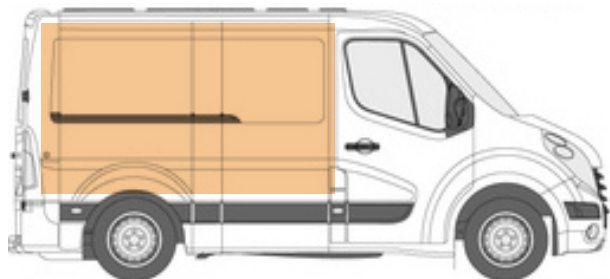

LATO GUIDA - SINISTRO

PASSO 3182 mm

COTÉ CONDUCTEUR - GAUCHE

EMPATTEMENT 3182 mm

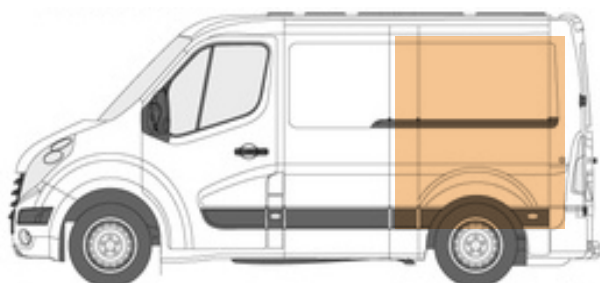

LATO PASSEGGERO - DESTRO

PASSO 3182 mm

COTÉ PASSAGER - DROIT

EMPATTEMENT 3182 mm

OPEL MOVANO L2

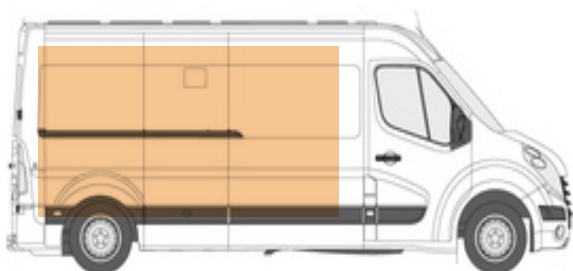

LATO GUIDA - SINISTRO

PASSO 3682 mm

COTÉ CONDUCTEUR - GAUCHE

EMPATTEMENT 3682 mm

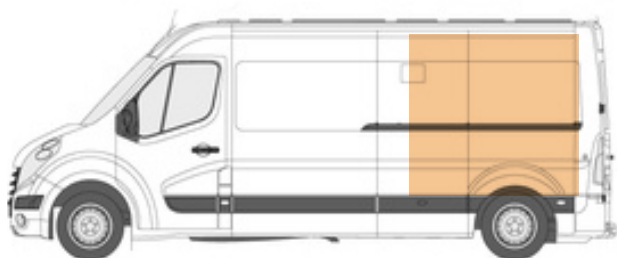

LATO PASSEGGERO - DESTRO

PASSO 3682 mm

COTÉ PASSAGER - DROIT

EMPATTEMENT 3682 mm



DIMENSIONI - DIMENSIONS	CODICE - CODE
L=1775 H=1566 P=360 mm	9KT1775008



DIMENSIONI - DIMENSIONS	CODICE - CODE
L=1775 H=1550 P=360 mm	9KT1775009



DIMENSIONI - DIMENSIONS	CODICE - CODE
L=1775 H=1566 P=360 mm	9KT1775010



DIMENSIONI - DIMENSIONS	CODICE - CODE
L=1014 H=1567 P=360 mm	9KT1014021



DIMENSIONI - DIMENSIONS	CODICE - CODE
L=1014 H=1559 P=320 mm	9KT1014022



DIMENSIONI - DIMENSIONS	CODICE - CODE
L=1014 H=1438 P=360 mm	9KT1014023



DIMENSIONI - DIMENSIONS	CODICE - CODE
L=2535 H=1600 P=360 mm	9KT2535001



DIMENSIONI - DIMENSIONS	CODICE - CODE
L=2535 H=1680 P=360 mm	9KT2535002



DIMENSIONI - DIMENSIONS	CODICE - CODE
L=2535 H=1790 P=360 mm	9KT2535004



DIMENSIONI - DIMENSIONS	CODICE - CODE
L=1268 H=1426 P=360 mm	9KT1268016



DIMENSIONI - DIMENSIONS	CODICE - CODE
L=1268 H=1561 P=360 mm	9KT1268017



DIMENSIONI - DIMENSIONS	CODICE - CODE
L=1268 H=1561 P=320 mm	9KT1268018

OPEL MOVANO L3

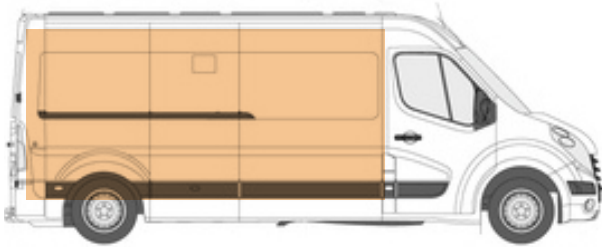

LATO GUIDA - SINISTRO

PASSO 4332 mm

COTÉ CONDUCTEUR - GAUCHE

EMPATTEMENT 4332 mm

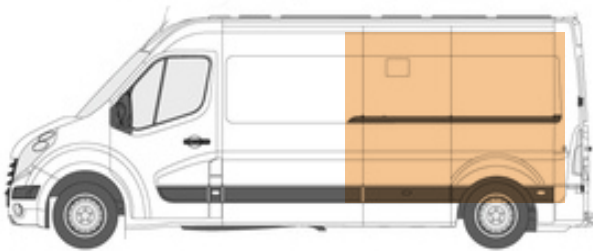

LATO PASSEGGERO - DESTRO

PASSO 4332 mm

COTÉ PASSAGER - DROIT

EMPATTEMENT 4332 mm





DIMENSIONI - DIMENSIONS	CODICE - CODE
L=3042 H=1720 P=360 mm	9KT3042001



DIMENSIONI - DIMENSIONS	CODICE - CODE
L=3042 H=1710 P=360 mm	9KT3042002



DIMENSIONI - DIMENSIONS	CODICE - CODE
L=3042 H=1720 P=360 mm	9KT3042003



DIMENSIONI - DIMENSIONS	CODICE - CODE
L=2028 H=1679 P=360 mm	9KT2028001



DIMENSIONI - DIMENSIONS	CODICE - CODE
L=2028 H=1679 P=360 mm	9KT2028002



DIMENSIONI - DIMENSIONS	CODICE - CODE
L=1775 H=1669 P=360 mm	9KT1775004





SCAFFALATURA EXPRESS

Siamo lieti di presentarvi il nuovo sistema di SCAFFALATURE EXPRESS. Tale sistema è stato progettato per trasportare prodotti di tutte le dimensioni. Con semplici gesti potrete adattare la scaffalatura a qualsiasi tipo di carico. Questa soluzione si adatta in particolare modo come allestimento per servizi pacchi come ad esempio DPD, DHL, UPS, GLS etc., dal momento che ottimizza il vano di carico ed assicura il trasporto di colli grandi e piccoli così come di merce voluminosa. **IMPORTANTE:** Per l'installazione delle scaffalature Express è necessaria la paratia divisoria tra il vano di carico e il vano passeggeri.

ÉTAGERES EXPRESS

Le système de rangement ETAGERES EXPRESS ORDER SYSTEM convient parfaitement aux entreprises de transport de colis ou matériel maintenance. Ces étagères ont été conçues pour transporter n'importe quel colis en toute sécurité. En effet, en quelques mouvements, l'étagère s'adapte à vos exigences de transport : En position horizontale, l'étagère devient pratique et sûre pour le transport des paquets de petites ou moyennes tailles. Une fois repliée le long de la paroi, l'étagère offre ainsi un espace de chargement pour les colis de grandes tailles et volumineux. Légère, résistante aux chocs et modulable, l'étagère Express est le système d'aménagement le plus sûr et le plus avantageux pour la personne en charge des livraisons. Elle peut ainsi optimiser et utiliser au maximum la zone de chargement, tout en augmentant la sécurité des hommes et du matériel transporté sur la route. **CONSEIL IMPORTANT:** l'installation du système ETAGERES EXPRESS nécessite une cloison de séparation entre le compartiment de chargement et la cabine de conduite.



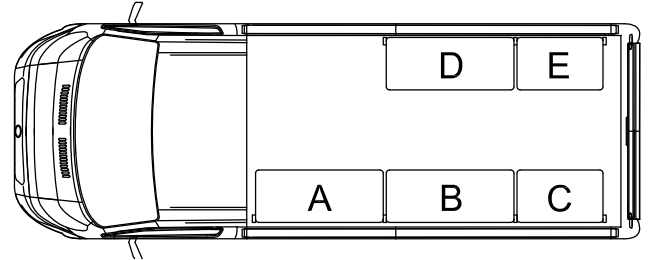
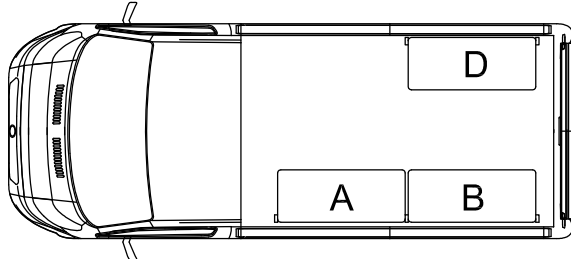

Veicolo Véhicule	Passo Empattement	Tetto Hauteur	H Montanti H Montants	Larghezza Ripiani Largeur Plateau				
				A	B	C	D	E
OPEL VIVARO 2014	L1 3098	H1	1305	1025	825		825	
	L2 3498	H1	1305	1225	1025		1225	
OPEL MOVANO 2010	L1 3182	H1	1620	825	1025		1025	
	L1 3182	H2	1830	825	1025		1025	
	L2 3682	H2	1830	1025	1225		1225	
	L2 3682	H3	1935	1025	1225		1225	
	L3 4332	H2	1830	1525	1525	825		1025
	L3 4332	H3	1935	1525	1525	825		1025

EXP 001

LATO SINISTRO L X P X H	PESO KG	LATO DESTRO L X P X H
1978 x 500 x 1305	42,90	904 x 500 x 1305

- 2 ripiani L=825 / 2 étagères L=825
- 1 ripiano L=1025 / 1 étagère L=1025

LATO SINISTRO - COTÉ GAUCHE | LATO DESTRO - COTÉ DROIT

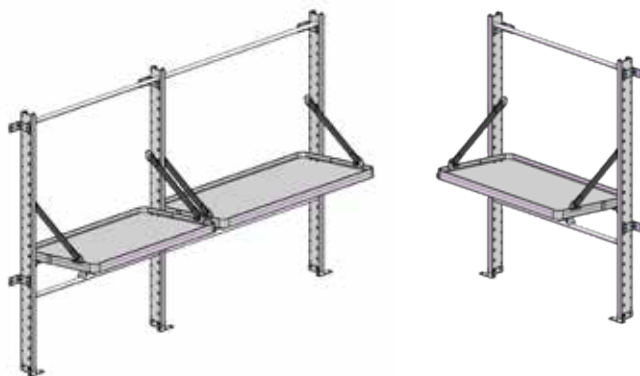

EXP 002

LATO SINISTRO L X P X H	PESO KG	LATO DESTRO L X P X H
2372 x 500 x 1725	80,70	1104 x 500 x 1725

- 4 ripiani L=1025 / 4 étagères L=1025
- 2 ripiani L=1225 / 2 étagères L=1225

LATO SINISTRO - COTÉ GAUCHE | LATO DESTRO - COTÉ DROIT

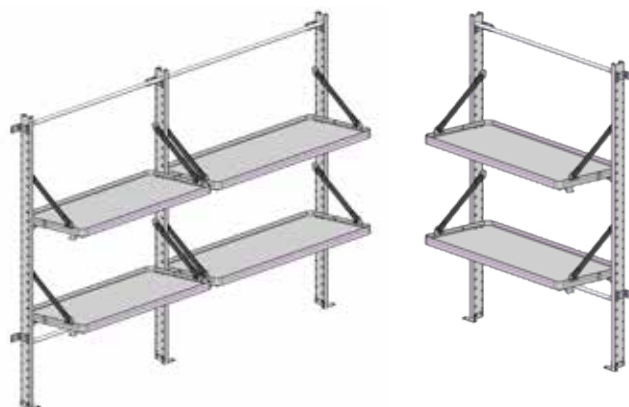

EXP 003

LATO SINISTRO L X P X H	PESO KG	LATO DESTRO L X P X H
2372 x 500 x 1830	84,45	1304 x 500 x 1830

- 4 ripiani L=1025 / 4 étagères L=1025
- 2 ripiani L=1225 / 2 étagères L=1225

LATO SINISTRO - COTÉ GAUCHE | LATO DESTRO - COTÉ DROIT

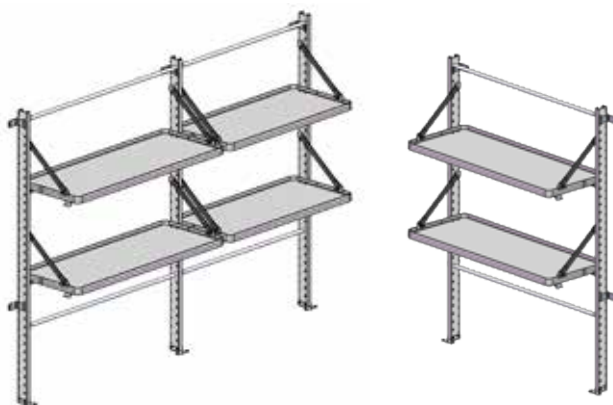

MODELLO	ANNO	EXP001	EXP002	EXP003
OPEL				
VIVARO L2 H1	2014	•		
MOVANO L2 H2	2010			•

MODELLO - MODÈLE | ANNO - ANNÉE



**SELLA PORTACAVI
SUPPORT DE CABLES**

DIMENSIONI - DIMENSIONS	CODICE - CODE
190x130x70mm	9SP0000022
260x200x110mm	9SP0000026
340x240x240mm	9SP0000032

Struttura in alluminio che permette di sorreggere cavi e può essere fissata sia nei moduli Order sia sul furgone.
Structure en aluminium peint qui permet de supporter des câbles. Il peut être fixé aux modules ORDER ou directement sur le véhicule.



**PORTAROTOLO
DÉROULEUR DE PAPIER**

DIMENSIONI - DIMENSIONS	DIMENSIONI CARTA - TAILLE DE PAPIER	CODICE - CODE
250x130x170mm	Ø 150 mm	9APC000002
270x170x260mm	Ø 200 mm	9APC000001

Struttura in alluminio verniciato a polveri, dotato di sistema che impedisce lo srotolamento della carta.
Structure en aluminium peint doté d'un système empêchant le papier de se dérouler.



**DOSATORE LAVAMANI 1000 ML
DOSEUR POUR SAVON 1000 ML**

DIMENSIONI - DIMENSIONS	CODICE - CODE
108X275X104mm	9ADS000001



**TASCHE IN ALLUMINIO
PORTE-DOCUMENTS EN ALUMINIUM**

DIMENSIONI - DIMENSIONS	CODICE - CODE
220X240X40mm	9ATA400000



**PLAFONIERA AL LED 240 LUMEN 12V
PLAFONNIER À LED 240 LUMENS 12V**

DIMENSIONI - DIMENSIONS	CODICE - CODE
360X9X25mm	9APLED0063
590X9X25mm	9APLED0064



PORTA TANICA CON TANICA IN PLASTICA 10L
PORTE-JERRYCAN ET JERRYCAN PLASTIQUE 10L

DIMENSIONI - DIMENSIONS	CODICE - CODE
318X340X158mm	9APTN00002

Portatanica con tanica in plastica con pratico rubinetto che permette di regolare il flusso dell'acqua.
Porte-jerrycan et jerrycan plastique avec robinet permettant de réguler le débit de l'eau.



PORTA TANICA CON TANICA IN FERRO 20L
PORTE-JERRYCAN AVEC JERRYCAN EN FER 20L

DIMENSIONI - DIMENSIONS	CODICE - CODE
351X472X175mm	9APTN00002

Portatanica in alluminio compreso di tanica in ferro da 20L adatta per il trasporto di oli o carburanti.
Porte-jerrycan en aluminium et jerrycan en fer (20L) pour transport d'huile ou de carburant.



PORTATANICA +TANICA CARBURANTI IN PLASTICA LT.10
PORTE-JERRYCAN AVEC JERRYCAN EN PLASTIQUE 10L POUR CARBURANT

DIMENSION - ABMESSUNGEN	CODE - CODE
315X312X191mm	9APTN00003

Portatanica in alluminio con tanica in plastica da 10L adatta per il trasporto di oli o carburanti.
Porte-jerrycan en aluminium et jerrycan en fer (20L) pour transport d'huile ou de carburant.



PANNELLO FORATO PORTAUTENSILI CON KIT DI 10 GANCI
PANNEAU PERCÉ PORTE-OUTILLAGE AVEC KIT DE 10 CROCHETS

DIMENSIONI - DIMENSIONS	CODICE - CODE
360X483X10mm	9APFFG4836



CASSETTA PRIMO SOCCORSO
MALLETE DE PREMIERS SECOURS

DIMENSIONI - DIMENSIONS	CODICE - CODE
340x240x240mm	9ACP000001

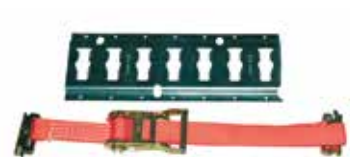

BARRA FERMACARICO IN ACCIAIO CON CINGHIA
RAIL UNIVERSEL EN ALUMINIUM AVEC SANGLE

DIMENSIONI - DIMENSIONS	CODICE - CODE
L 360 + L 600 mm	9ABF000001



MENSOLA PORTA SILICONI
ÉTAGÈRE PORTE BOMBES SILICONES

DIMENSIONI - DIMENSIONS	CODICE - CODE
Ø 50 mm	9APSIL0360



MENSOLA PORTA BOMBOLETTE Ø70 mm PER PANNELLO FORATO
TABLETTE PORTE-BOMBE DE SPRAY Ø70 mm POUR PANNEAU PERCÉ

DIMENSIONI - DIMENSIONS	CODICE - CODE
283x74x87 mm	9AGPF23176

CENTRI SPECIALIZZATI IN TUTTA EUROPA

Installazione ed assistenza

CENTRES SPECIALISÉS DANS TOUTE EUROPE

Installation et assistance

CONTATTA IL PUNTO DI ALLESTIMENTO PIU' VICINO:

VEUILLEZ CONTACTER LE CENTRE DE POSE LE PLUS PROCHE DE CHEZ VOUS :

www.ordersystem.it

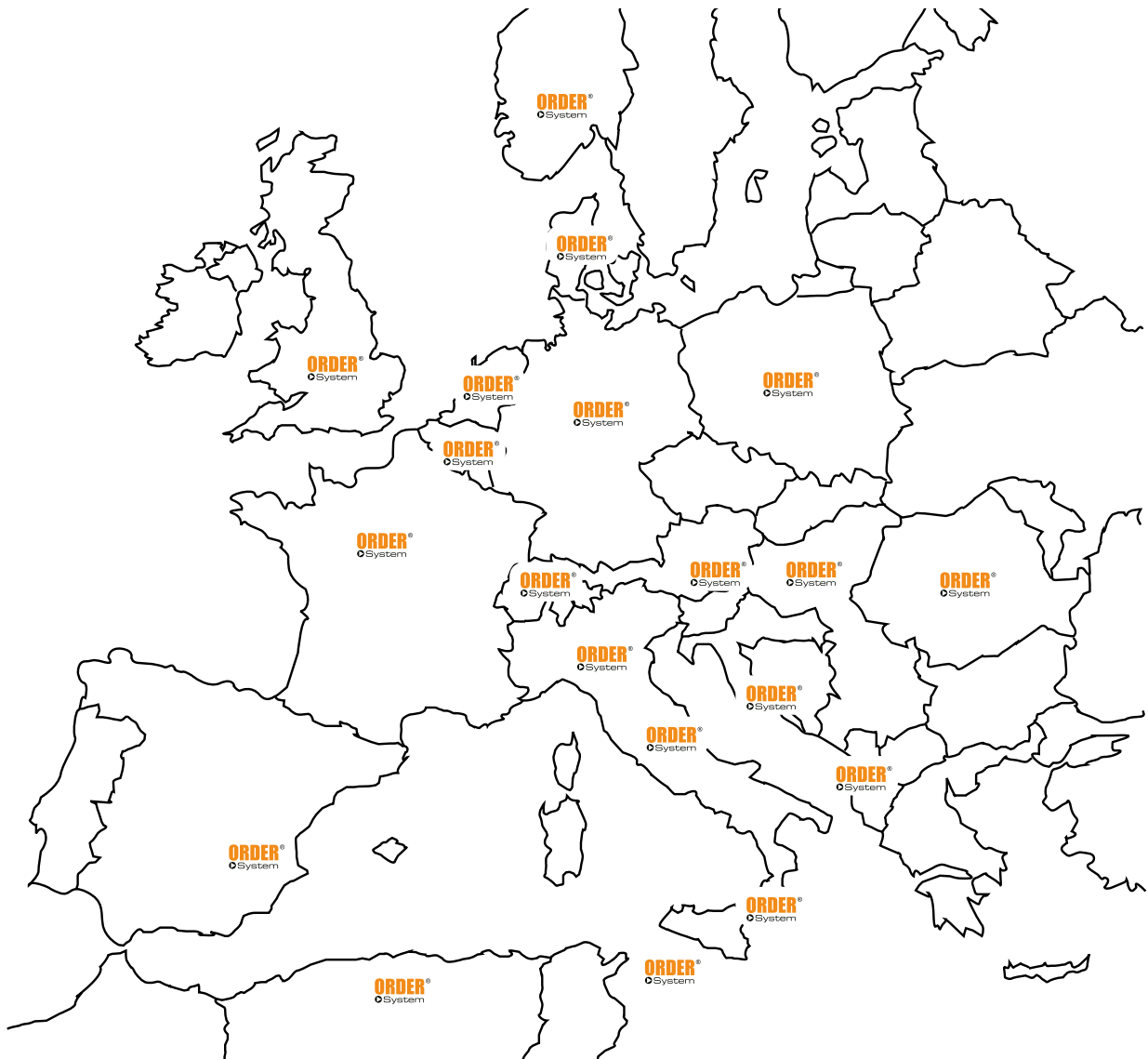



TECNO A srl.

Via del Lavoro, 4
Loc. Canavaccio 61029 Urbino PU ITALY

T. +39 0722 354048 F. +39 0722 354049

info@ordersystem.it

TIMBRO DEL RIVENDITORE - CACHET DU DISTRIBUTEUR: